



---

# Inverter

i510 cabinet frequency inverter

0.25 kW ... 15 kW

0.33 hp ... 20 hp



---

## Contents

<b>About this document</b> .....	<b>8</b>
Document description .....	8
Further documents .....	8
Notations and conventions .....	9
<b>Product information</b> .....	<b>10</b>
Product description .....	10
The concept .....	10
Load characteristics .....	10
Features .....	11
Topologies / network .....	14
Functions .....	15
Overview .....	15
Motor control types .....	15
Motor functions .....	16
Motor setting range .....	16
Identification of the products .....	18
Ways of commissioning .....	21
<b>Safety instructions</b> .....	<b>22</b>
Basic safety instructions .....	22
Application as directed .....	23
Foreseeable misuse .....	23
Handling .....	24
Residual hazards .....	26
<b>Information on project planning</b> .....	<b>28</b>
Project planning process .....	28
Dimensioning .....	28
Operation in motor and generator mode .....	30
Overcurrent operation .....	31
Control cabinet structure .....	32
Arrangement of components .....	32
Cables .....	33
Earthing concept .....	33
<b>Mechanical installation</b> .....	<b>34</b>
Important notes .....	34
Preparation .....	35

# Contents

---

<b>Electrical installation</b> .....	<b>36</b>
Important notes.....	36
Electrical isolation .....	37
Preparation.....	38
EMC-compliant installation.....	39
Mains connection.....	39
Motor cable.....	40
Control cables .....	40
Fieldbus cables, networks.....	41
Detecting and eliminating EMC interferences.....	42
Connection according to UL.....	43
Important notes .....	43
Fusing data.....	44
Branch Circuit Protection (BCP) with standard fuses or circuit breakers.....	44
Approved manufacturers for semiconductor fuses.....	46
Mains connection .....	47
1-phase mains connection 230/240 V.....	48
3-phase mains connection 230/240 V.....	50
3-phase mains connection 400 V.....	51
3-phase mains connection 480 V.....	52
Motor connection.....	53
Connection to the IT system.....	54
Control connections.....	55
Networks.....	56
CANopen/Modbus.....	56

---

<b>Technical data</b> .....	<b>57</b>
Standards and operating conditions.....	57
Conformities and approvals.....	57
Protection of persons and device protection.....	57
EMC data.....	58
Motor connection.....	58
Environmental conditions.....	58
Electrical supply conditions.....	59
1-phase mains connection 230/240 V.....	60
Rated data.....	60
Fusing data (EN 60204-1).....	65
Connection data.....	66
RFI filters / Mains filters.....	67
Low Leakage.....	68
Short distance filter.....	69
Long distance filter.....	69
3-phase mains connection 230/240 V.....	70
Rated data.....	70
Fusing data (EN 60204-1).....	74
Connection data.....	75
3-phase mains connection 230/240 V "Light Duty".....	76
Rated data.....	76
Fusing data (EN 60204-1).....	78
Connection data.....	78
3-phase mains connection 400 V.....	79
Rated data.....	79
Fusing data (EN 60204-1).....	83
Connection data.....	84
RFI filters / Mains filters.....	85
Short distance filter.....	86
Long distance filter.....	87
Sine filters.....	88
3-phase mains connection 400 V "Light Duty".....	89
Rated data.....	89
Fusing data (EN 60204-1).....	92
Connection data.....	92
RFI filters / Mains filters.....	93
Short distance filter.....	94
Long distance filter.....	94
3-phase mains connection 480 V.....	95
Rated data.....	95
Fusing data (EN 60204-1).....	99
Connection data.....	100
RFI filters / Mains filters.....	101
Short distance filter.....	102
Long Distance filter.....	103

# Contents

---

3-phase mains connection 480 V "Light Duty".....	104
Rated data.....	104
Fusing data (EN 60204-1).....	107
Connection data.....	107
RFI filters / Mains filters.....	108
Short distance filter.....	109
Long distance filter.....	109
Ecodesign Directive.....	110
Dimensions.....	113
<b>Product extensions.....</b>	<b>124</b>
Overview.....	124
I/O extensions.....	125
Basic I/Os.....	125
Data of control connections.....	126
Further control connections.....	128
Relay output.....	128
Networks.....	129
CANopen.....	130
Modbus RTU.....	131
<b>Accessories.....</b>	<b>132</b>
Overview.....	132
Operation and diagnostics.....	133
Keypad.....	133
External keypad.....	133
USB module.....	134
WLAN module.....	135
Blanking cover.....	136
Control and display elements.....	136
Potentiometer.....	136
Memory modules.....	137
Memory module copier.....	137
Mains chokes.....	137
RFI filters / Mains filters.....	138
Sine filter.....	139
Brake switches.....	139
Mounting.....	140
Shield mounting kit.....	140
Terminal strips.....	141
DIN rail.....	142
<b>Purchase order.....</b>	<b>143</b>
Notes on ordering.....	143
Order code.....	144
<b>Environmental notes and recycling.....</b>	<b>145</b>

---

**Appendix** ..... **146**

    Good to know ..... 146

        Operating modes of the motor ..... 146

        Motor control types ..... 148

        Switching frequencies ..... 150

        Enclosures ..... 151

    Glossary ..... 152

# About this document

## Document description



## About this document

### Document description

This document is intended for all persons who want to configure inverters with the products described.

This document assists you with the configuration and selection of your product. It contains information on mechanical and electrical installation, on product expansions, and on accessories.

### Further documents

For certain tasks, information is available in further documents.

Document	Contents/topics
Mounting sheet	General safety instructions and important UL/CSA instructions, connection diagram and technical data. <ul style="list-style-type: none"><li>The mounting sheet is included in the delivery of the product.</li></ul>
Operating instructions	Basic information on installing and commissioning the product.
Commissioning manual	Detailed information on setting and parameterizing the product.

### More information

For certain tasks, information is available in other media.

Medium	Contents/topics
Engineering Tools	For commissioning
AKB articles	Additional technical information for users in the Application Knowledge Base
CAD data	Download in different formats from the EASY Product Finder
EPLAN macros	Project planning, documentation and management of projects for EPLAN P8.
Device descriptions	Standardized files for network configuration



Information and tools with regard to the Lenze products can be found on the Internet:





[www.Lenze.com](http://www.Lenze.com) → Downloads





## Notations and conventions

Conventions are used in this document to distinguish between different types of information.

Numeric notation		
Decimal separator	Point	Generally shown as a decimal point. Example: 1 234.56
Warnings		
UL Warnings	UL	Are used in English and French.
UR warnings	UR	
Text		
Engineering Tools	" "	Software Example: "Engineer", "EASY Starter"
Icons		
Page reference		Reference to another page with additional information. Example:  16 = see page 16
Documentation reference		Reference to other documentation with additional information. Example:  EDKxxx = see documentation EDKxxx

### Layout of the safety instructions

#### **DANGER!**

Indicates an extremely hazardous situation. Failure to comply with this instruction will result in severe irreparable injury and even death.

#### **WARNING!**

Indicates an extremely hazardous situation. Failure to comply with this instruction may result in severe irreparable injury and even death.

#### **CAUTION!**

Indicates a hazardous situation. Failure to comply with this instruction may result in slight to medium injury.

#### **NOTICE**

Indicates a material hazard. Failure to comply with this instruction may result in material damage.

# Product information

Product description  
The concept



## Product information

### Product description

The i510 cabinet frequency inverter is a compact control cabinet device with scalable functionality. It is versatile, reliable and easy to use.

The requirements of the Ecodesign Directive, Standard EN 50598-2, are met.

Application areas: Conveyor drives, traveling drives, pumps, fans, agitators, ...

Overview				
Power range	0.25 ... 15 kW			
Mains connection	1 x 230 V	3 x 230 V	3 x 400 V	3 x 480 V
Degree of protection	IP20			
Communication	CANopen, Modbus RTU			

### Highlights

- Space saving design: 60 mm wide (up to 4 kW), 130 mm deep (up to 11 kW), with zero-clearance mounting
- Innovative interaction (e.g. over WLAN) makes new record-breaking commissioning times and convenient diagnostics a reality
- Special user-friendliness
- Can be directly connected without external cooling
- All typical motor control types of modern inverters
- Stroke and continuous operation of the motor according to common operating modes
- Networking options via CANopen/Modbus
- Extensive integrated functions

### The concept

The i510 cabinet frequency inverter consisting of Control Unit and Power Unit is always supplied as a complete inverter.

2 variants are available:

- Without network
- With CANopen/Modbus, switchable

### Load characteristics

The inverters have two different load characteristics: "Light Duty" and "Heavy Duty".

The "Light Duty" load characteristic allows for a higher output current with restrictions regarding overload capacity, ambient temperature and switching frequency. This allows the motor required for the application to be driven by a less powerful inverter. Select the load characteristic according to the application.

	Heavy Duty	Light Duty
Characteristic	High dynamic requirements	Low dynamic requirements
Typical applications	Main tool drives, travelling drives, hoist drives, winders, forming drives and conveyors	Pumps, fans, general horizontal materials handling technology and line drives
Overload capacity	3 s/200 %, 60 s/150 % See technical data	Restricted See technical data



## Features

The following figures give an overview of the elements and connections on the devices. Position, size and appearance of elements and connections may vary depending on the capacity and size of the equipment.

Some equipment may be optional.

### Example of 0.25 kW ... 4 kW

PE connection

**X100** Mains connection

**X9** Relay output

IT screw from 0.55 kW

**X216** Network, Option

**X20** Memory module

Network status LEDs

Inverter status LEDs

Network shield connection, Option

Selector CAN open/Modbus

Internal interface

Diagnostic module

Shielding of control connections

**X3** Control terminals Basic I/O

IT screw

**X105** Motor connection

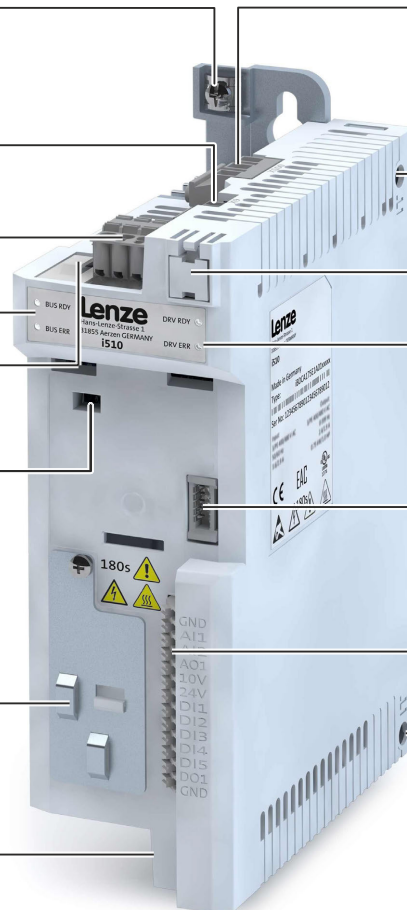

# Product information

## Features



### Example of 5.5 kW

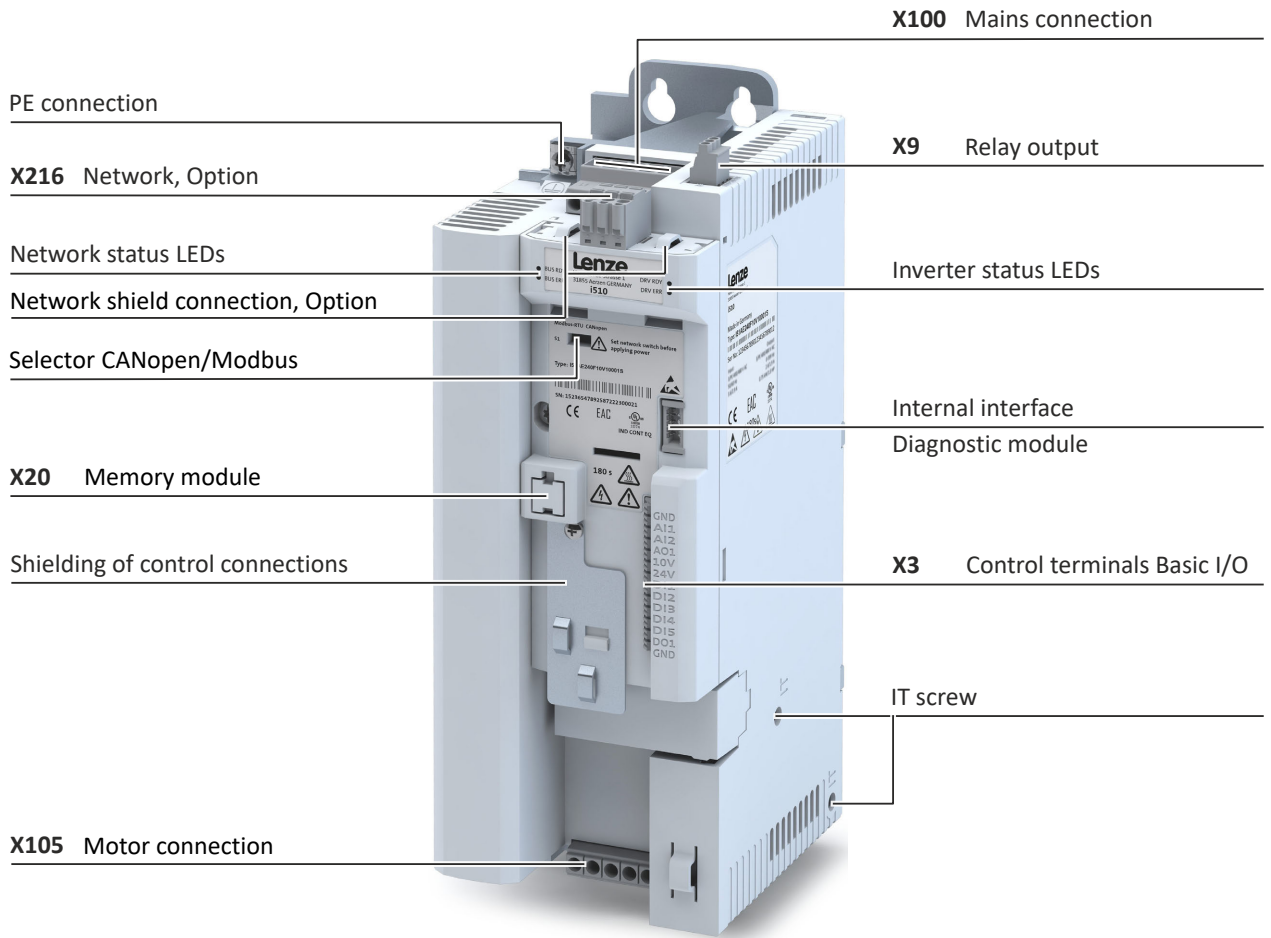



**Example of 7.5 kW ... 11 kW**

PE connection

**X100** Mains connection

Network shield connection, Option

**X9** Relay output

**X216** Network, Option

Network status LEDs

Inverter status LEDs

Selector CANopen/Modbus

Internal interface

Diagnostic module

**X20** Memory module

**X3** Control terminals Basic I/O

Shielding of control connections

IT screw

**X105** Motor connection

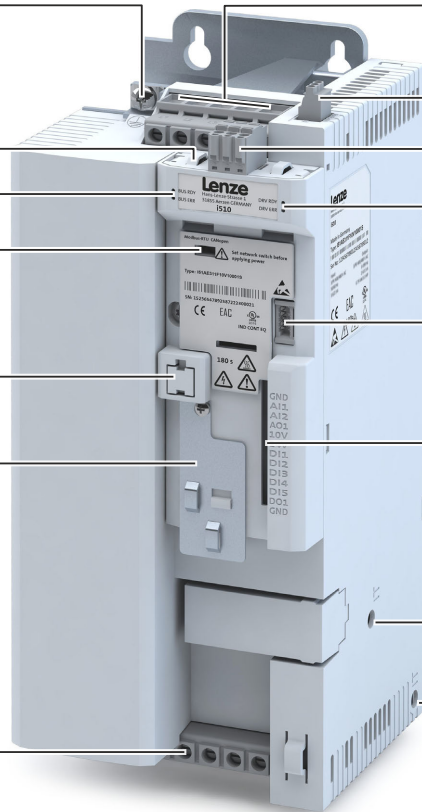

**Position and meaning of the nameplates**



- ① Technical data
- ② Type and serial number of the inverter

# Product information

Features  
Topologies / network





---

## Topologies / network

The inverters can be equipped with different fieldbus networks.

The topologies and protocols typical for the prevailing networks are supported.

Currently available networks:

	<p>CANopen® is a communication protocol based on CAN. CANopen® is a registered community trademark of the CAN user organisation CiA® (CAN in Automation e. V.). Device descriptions for the download: <a href="#">EDS files for Lenze devices</a></p>
	<p>The Modbus protocol is an open communication protocol based on a client/server architecture and developed for the communication with programmable logic controllers. Further development is carried out by the international user organisation Modbus Organization, USA.</p>

More information on the supported networks can be found at:

[www.Lenze.com](http://www.Lenze.com)



## Functions

### Overview

The inverters i510 are adjusted to simple applications regarding their functionality.

Functions	
Motor control	Monitoring
V/f characteristic control linear/square-law (VFC plus)	Short circuit
Energy saving function (VFC-ECO)	earth fault
Sensorless vector control (SLVC)	Device overload monitoring ( $i^*t$ )
Sensorless control for synchronous motors (SL-PSM/SLSM-PSM)	Motor overload monitoring ( $i^2*t$ )
Torque mode	Mains phase failure
Motor functions	Stalling protection
Flying restart circuit	Motor current limit
Slip compensation	Maximum torque
DC braking	Ultimate motor current
Oscillation damping	Motor speed monitoring
Skip frequencies	Load loss detection
Automatic identification of the motor data	Diagnostics
Brake energy management	Error history buffer
Holding brake control	Logbook
Voltage add – function	LED status displays
Rotational Energy Ride Through (RERT)	Keypad language selection German, English
Application functions	Network
Process controller	CANopen
Process controller - idle state and rinse function	Modbus RTU
Freely assignable favourite menu	
Parameter change-over	
S-shaped ramps for smooth acceleration	
Motor potentiometer	
Flexible I/O configuration	
Access protection	
Automatic restart	
OEM parameter set	
Sequencer	
Complete control with 8-key keypad	
UPS operation	
"Light Duty" load characteristic can be adjusted for selected inverters	

### Motor control types

The following table contains the possible control types with Lenze motors.

Motors	V/f characteristic control	Sensorless vector control
	VFCplus	SLVC
Three-phase AC motors		
MD	•	•
MF	•	•
mH	•	•
m500	•	•

# Product information

Functions  
Motor functions



## Motor functions

### Motor setting range

#### Rated point 120 Hz



Only possible with Lenze MF motors.

The rated motor torque is available up to 120 Hz.

Compared to the 50-Hz operation, the setting range increases by 2.5 times.

Thus, a smaller motor can be selected at the same rated power.

#### V/f at 120 Hz

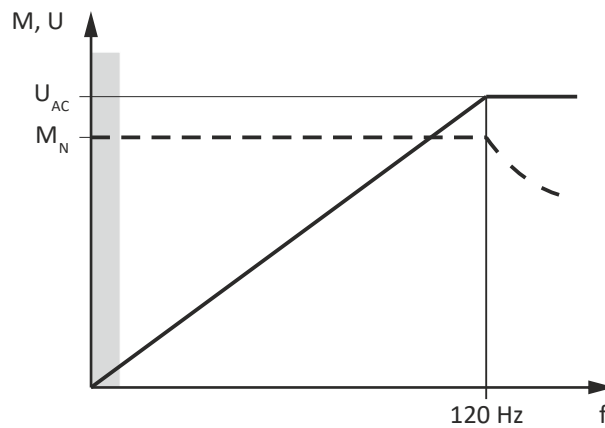

V Voltage  
M Torque  
f Frequency

$V_{AC}$  Mains voltage  
 $M_N$  Rated torque





### Rated point 87 Hz

The rated motor torque is available up to 87 Hz.

Compared to the 50-Hz operation, the setting range increases by 1.74 times.

For this purpose, a motor with 230/400 V in a triangle is driven by a 400 V inverter.

The inverter must be dimensioned for a rated motor current of 230 V.

### V/f at 87 Hz

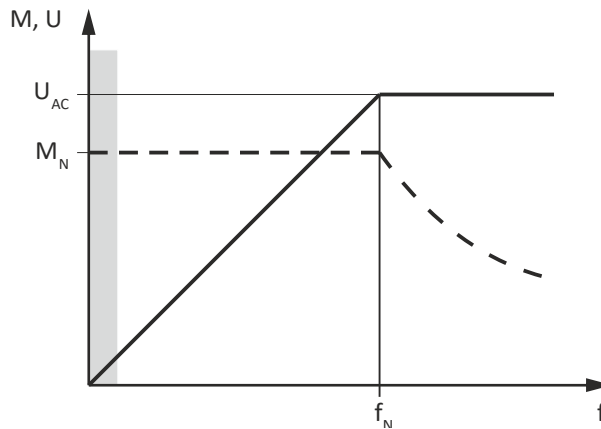

V Voltage  
M Torque  
f Frequency

$U_{AC}$  Mains voltage  
 $M_{rated}$  Rated torque  
 $f_{rated}$  Rated frequency

### Rated point 50 Hz

The rated motor torque is available up to 50 Hz.

### V/f at 50 Hz

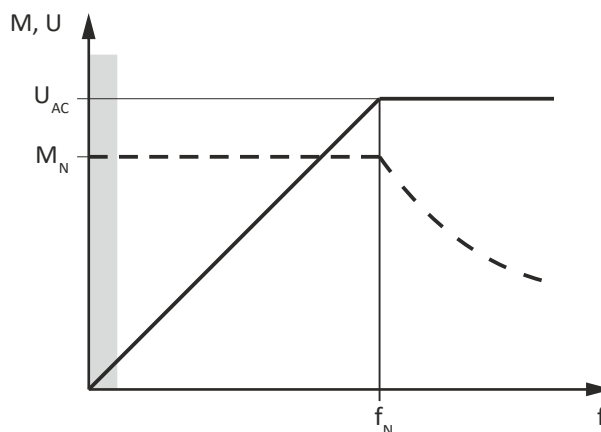

V Voltage  
M Torque  
f Frequency

$U_{AC}$  Mains voltage  
 $M_{rated}$  Rated torque  
 $f_{rated}$  Rated frequency

# Product information

## Identification of the products



### Identification of the products

When the technical data of the different versions was listed, the product name was entered because it is easier to read than the individual product code of the product. The product name is also used for categorising the accessories. The assignment of product name and order code can be found in the "Order" chapter. [144](#)

The product name contains the power in kW, the mains voltage class 120 V, 230 V or 400 V and the number of phases.

In the product name, the power information always refers to the "Heavy Duty" load characteristic.

The 1/3-phase inverters are marked at the end with "-2".

"C" marks the "Cabinet" version = inverter for the installation into the control cabinet.

Device series	Design	Rated power		Rated mains voltage	No. of phases	Inverter
		Light Duty	Heavy Duty			
		kW	kW	V		
i510	C	-	0.25	230	1	i510-C0.25/230-1
					1/3	i510-C0.25/230-2
			0.37		1	i510-C0.37/230-1
					1/3	i510-C0.37/230-2
			0.55		1	i510-C0.55/230-1
					1/3	i510-C0.55/230-2
			0.75		1	i510-C0.75/230-1
					1/3	i510-C0.75/230-2
			1.1		1	i510-C1.1/230-1
					1/3	i510-C1.1/230-2
			1.5		1	i510-C1.5/230-1
					1/3	i510-C1.5/230-2
			2.2		1	i510-C2.2/230-1
					1/3	i510-C2.2/230-2

Device series	Design	Rated power		Rated mains voltage	No. of phases	Inverter		
		Light Duty	Heavy Duty					
		kW	kW	V				
i510	C	-	0.25	240	1/3	i510-C0.25/230-2		
						0.37	i510-C0.37/230-2	
			0.55				i510-C0.55/230-2	
						0.75	i510-C0.75/230-2	
			1.1				i510-C1.1/230-2	
						1.5	i510-C1.5/230-2	
			2.2				i510-C2.2/230-2	
						5.5	4	3
		7.5	5.5		i510-C5.5/230-3			



# Product information

Identification of the products

Device series	Design	Rated power		Rated mains voltage	No. of phases	Inverter
		Light Duty	Heavy Duty			
		kW	kW			
i510	C	-	0.37	400	3	i510-C0.37/400-3
			0.55			i510-C0.55/400-3
			0.75			i510-C0.75/400-3
			1.1			i510-C1.1/400-3
			1.5			i510-C1.5/400-3
			2.2			i510-C2.2/400-3
		4	3			i510-C3.0/400-3
		5.5	4			i510-C4.0/400-3
		7.5	5.5			i510-C5.5/400-3
		11	7.5			i510-C7.5/400-3
		15	11			i510-C11/400-3

Device series	Design	Rated power		Rated mains voltage	No. of phases	Inverter
		Light Duty	Heavy Duty			
		kW	kW			
i510	C	-	0.37	480	3	i510-C0.37/400-3
			0.55			i510-C0.55/400-3
			0.75			i510-C0.75/400-3
			1.1			i510-C1.1/400-3
			1.5			i510-C1.5/400-3
			2.2			i510-C2.2/400-3
		4	3			i510-C3.0/400-3
		5.5	4			i510-C4.0/400-3
		7.5	5.5			i510-C5.5/400-3
		11	7.5			i510-C7.5/400-3
		15	11			i510-C11/400-3

# Product information

## Identification of the products



### Product code

		I	5	1	A	E	□□□	□	1	0	□	□	□	□□□□
Product type	Inverter	I												
Product family	i500		5											
Product	i510			1										
Product generation	Generation 1				A									
	Generation 2				B									
Mounting type	Control cabinet mounting					E								
Rated power (Examples)	0.25 kW						125							
	0.55 kW						155							
	2.2 kW						222							
Mains voltage and connection type	1/N/PE AC 230/240 V								B					
	1/N/PE AC 230/240 V								D					
	2/N/PE AC 230/240 V													
	3/PE AC 230/240 V								C					
	3/PE AC 400 V								F					
Motor connections	Single axis								1					
Integrated functional safety	Without								0					
Degree of protection	IP20									0				
	IP20, coated									V				
Interference suppression	Without										0			
	Integrated RFI filter										1			
Application	Default parameter setting: Region EU (50-Hz networks)											0		
	Default parameter setting: Region US (60-Hz networks)											1		
Design types	Basic I/O without network													000S
	Basic I/O with CANopen/Modbus													001S

### Example:

Product code	Meaning
I51AE215F10010001S	Inverter i510 cabinet, 1.5 kW, three-phase, 400 V/480 V IP20, integrated RFI filter, 50-Hz version Basic I/O with CANopen/Modbus network



## Ways of commissioning

There are three ways to commission the inverter quickly and easily.

Thanks to Lenze's engineering philosophy, the high functionality is still easy to grasp. Parameterization and commissioning are a breeze thanks to clear structure and simple dialogs, leading to the desired outcome quickly and reliably.

### Keypad

If it's only a matter of setting a few key parameters such as acceleration and deceleration time, this can be done quickly on the keypad.



### »EASY Starter«

If functions such as the holding brake control or sequencer need to be set, it's best to use the »EASY Starter« engineering tool.



### SMART Keypad App

The Lenze SMART Keypad App for Android or iOS allows you to diagnose and parameterize an inverter. A WLAN module on the inverter is required for communication.

- Ideal for the parameterization of simple applications such as a conveyor belt.
- Ideal for the diagnostics of the inverter.

The app can be found in the Google Play Store or in the Apple App Store.

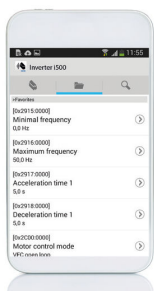

Android



iOS

# Safety instructions

## Basic safety instructions



---

## Safety instructions

### Basic safety instructions

Disregarding the following basic safety instructions and safety information may lead to severe personal injury and damage to property!

- Only use the product as directed.
- Never commission the product in the event of visible damage.
- Never modify the product technically.
- Never commission the product before assembly has been completed.
- Never operate the product without the required covers.
- Connect/disconnect all pluggable connections only in deenergized condition!
- Only remove the product from the installation in the deenergized state.
- The product can – depending on their degree of protection – have live, movable or rotating parts during or after operation. Surfaces can be hot.
- Observe the specifications of the corresponding documentation. This is the condition for safe and trouble-free operation and the achievement of the specified product features.
- The procedural notes and circuit details given in the associated documentation are suggestions and their transferability to the respective application has to be checked. The manufacturer of the product does not take responsibility for the suitability of the process and circuit proposals.
- All work with and on the product may only be carried out by qualified personnel. IEC 60364 and CENELEC HD 384 define the qualifications of these persons:
  - They are familiar with installing, mounting, commissioning, and operating the product.
  - They have the corresponding qualifications for their work.
  - They know and can apply all regulations for the prevention of accidents, directives, and laws applicable at the place of use.

Please observe the specific safety information in the other sections!



---

## Application as directed

- The product is a professional equipment intended for use by trades, specific professions or industry and not for sale to the general public. IEC 60050 [IEV 161-05-05]
- To prevent personal injury and damage to property, higher-level safety and protection systems must be used!
- All transport locks must be removed.
- The product may only be operated under the specified operating conditions and in the specified mounting positions.
- The product is exclusively suitable for installation in control cabinets and, depending on the protection class and design, for wall and motor mounting.
- The product must only be actuated with motors that are suitable for the operation with inverters.
- The product must not be operated in private areas, in potentially explosive atmospheres and in areas with harmful gases, oils, acids and radiation.

### Additional information for the intended use in North America:

The cables must be installed in accordance with US National Electrical Code NFPA 70 or Canadian Electrical Code C22.1.

### Use of explosion-protected motors

Explosion-protected motors that are not designed for use with an inverter lose their approval if they are used for variable speed applications. Due to the many areas of liability that may arise when handling these applications, the following policy statement applies:



---

Lenze inverters are sold without warranty of suitability for use with explosion-protected motors. Lenze assumes no responsibility for direct, incidental or consequential damages, costs or losses that may result from the use of AC inverters with explosion-protected motors. Buyer expressly agrees to assume any risk of loss, expense or damage that may result from such application.

---

### Foreseeable misuse

Inverters are not to be operated with DC motors.

# Safety instructions

## Handling



---

## Handling

### Transport, storage

Observe the notes regarding transport, storage and correct handling. Ensure proper handling and avoid mechanical stress. Do not bend any components and do not change any insulation distances during transport or handling. Do not touch any electronic components and contacts. Inverters contain electrostatically sensitive components which can easily be damaged by inappropriate handling. Do not damage or destroy any electrical components since thereby your health could be endangered!

### Installation

The technical data and supply conditions can be obtained from the nameplate and the documentation. They must be strictly observed.

The inverters must be installed and cooled according to the instructions given in the corresponding documentation. Observe the climatic conditions according to the technical data. The ambient air must not exceed the degree of pollution 2 according to EN 61800-5-1.

### Electrical connection

When working on energized inverters, comply with the applicable national accident prevention regulations.

The electrical installation must be carried out according to the appropriate regulations (e. g. cable cross-sections, fuses, PE connection). Additional information can be obtained from the documentation.

The documentation contains information about installation according to EMC regulations (shielding, grounding, filters and cable routing). Please also observe this information for CE-marked inverters. The manufacturer of the system or machine is responsible for adherence to the limit values required in connection with EMC legislation.

The inverters must be installed in housings (e. g. control cabinets) to meet the limit values for radio interferences valid at the site of installation. The housings must enable an EMC-compliant installation. Observe in particular that e. the control cabinet doors should have a circumferential metal connection to the housing. Reduce housing openings and cutouts to a minimum.

### Protection in the event of short circuit or earth fault

To ensure protection according to EN 61800-5-1 in the event of an electrical short circuit or earth fault (protection against electric shock, thermal hazards and fire), the following must be taken into account in the installation:

- Use fuses according to the technical data.
- The installation must meet the requirements of the IEC 60364.
- The continuity of all associated protective conductors and equipotential bonding conductors including all connection points must be ensured.
- If the maximum permissible switch-off time according to IEC 60364 is exceeded with a high system impedance (especially with TT mains) or a high loop impedance with the prescribed fuses, a residual current device (RCD) can be used. Alternatively, other protective measures can be used, e. g. isolation from the environment by means of double or reinforced insulation, or isolation from the supply system by using a transformer.
- If a residual current device (RCD) is connected upstream of the inverter for protection in the event of an earth fault, only type B/B+ is permitted for three-phase devices.

### Operation

If necessary, systems including inverters must be equipped with additional monitoring and protection devices. Also comply with the safety regulations and provisions valid at the installation site.

After the inverter has been disconnected from the supply voltage, all live components and power terminals must not be touched immediately because capacitors can still be charged. Please observe the corresponding stickers on the inverter.

All protection covers and doors must be shut during operation.





You may adapt the inverters to your application by parameter setting within the limits available. For this, observe the notes in the documentation.

### **Safety functions**

Certain inverter versions support safety functions (e. g. "safe torque off", formerly "safe standstill") according to the requirements of the EC Machinery Directive 2006/42/EC [UKCA: S.I. 2008/1597] . The notes on the integrated safety provided in this documentation must be observed.

### **Maintenance and servicing**

The inverters do not require any maintenance if the prescribed operating conditions are observed.

### **Disposal**

In accordance with the current provisions, Lenze products and accessories have to be disposed of by means of professional recycling. Lenze products contain recyclable raw material such as metal, plastics and electronic components.

# Safety instructions

## Residual hazards



### Residual hazards

Even if notes given are taken into consideration and protective measures are implemented, the occurrence of residual risks cannot be fully prevented.

The user must take the residual hazards mentioned into consideration in the risk assessment for his/her machine/system.

If the above is disregarded, this can lead to severe injuries to persons and damage to property!

#### Product

Observe the warning labels on the product!



**Dangerous electrical voltage:**

Before working on the product, make sure there is no voltage applied to the power terminals! After mains disconnection, the power terminals will still carry the hazardous electrical voltage for the time given next to the symbol!



**Electrostatic sensitive devices:**

Before working on the product, the staff must ensure to be free of electrostatic charge!



**High leakage current:**

Carry out fixed installation and PE connection in compliance with:  
EN 61800-5-1 / EN 60204-1



**Hot surface:**

Use personal protective equipment or wait until the device has cooled down!

#### Degree of protection - protection of persons and device protection

- Information applies to the mounted and ready-for-use state.
- Information does not apply to the wire range of the terminals.
  - Terminals that are not wired have low protection against physical contact.
  - Terminals for large cable cross-sections have lower classes of protection, e. g. from 15 kW IP10 only.

#### Protection of persons

Before working on the inverter, check if no voltage is applied to the power terminals.

- Depending on the device, the power terminals X105 remain live for up to 20 minutes.
- The power terminals X100 and X105 remain live even when the motor is stopped.

#### Device protection

- The maximum test voltage for insulation tests between a control potential of 24 V and PE must not exceed 110 V DC (EN 61800-5-1).

#### Motor protection

With some settings of the inverter, the connected motor can be overheated.

- E. g. by longer operation of self-ventilated motors at low speed.
- E. g. by longer operation of DC-injection braking.

#### Protection of the machine/system

Drives can reach dangerous overspeeds.

- E. g. by setting high output frequencies in connection with motors and machines not suitable for this purpose.
- The inverters do not provide protection against such operating conditions. For this purpose, use additional components.

Switch contactors in the motor cable only if the controller is inhibited.

- Switching while the inverter is enabled is only permissible if no monitoring functions are activated.



## **Motor**

If there is a short circuit of two power transistors, a residual movement of up to  $180^\circ$ /number of pole pairs can occur at the motor! (e. g. 4-pole motor: residual movement max.  $180^\circ/2 = 90^\circ$ ).

# Information on project planning

Project planning process  
Dimensioning



## Information on project planning

### Project planning process

#### Dimensioning

##### 3 methods for dimensioning

**Fast:** Selection of the inverter based on the motor data of a 4-pole asynchronous motor.

**Detailed:** In order to optimize the selection of the inverter and all drive components, it is worthwhile to execute the detailed system dimensioning based on the physical requirements of the application. For this purpose, Lenze provides the Drive Solution Designer (DSD) design program.

**Manual:** The following chapter guides you step by step through the selection of a drive system.

##### Workflow of a configuration process

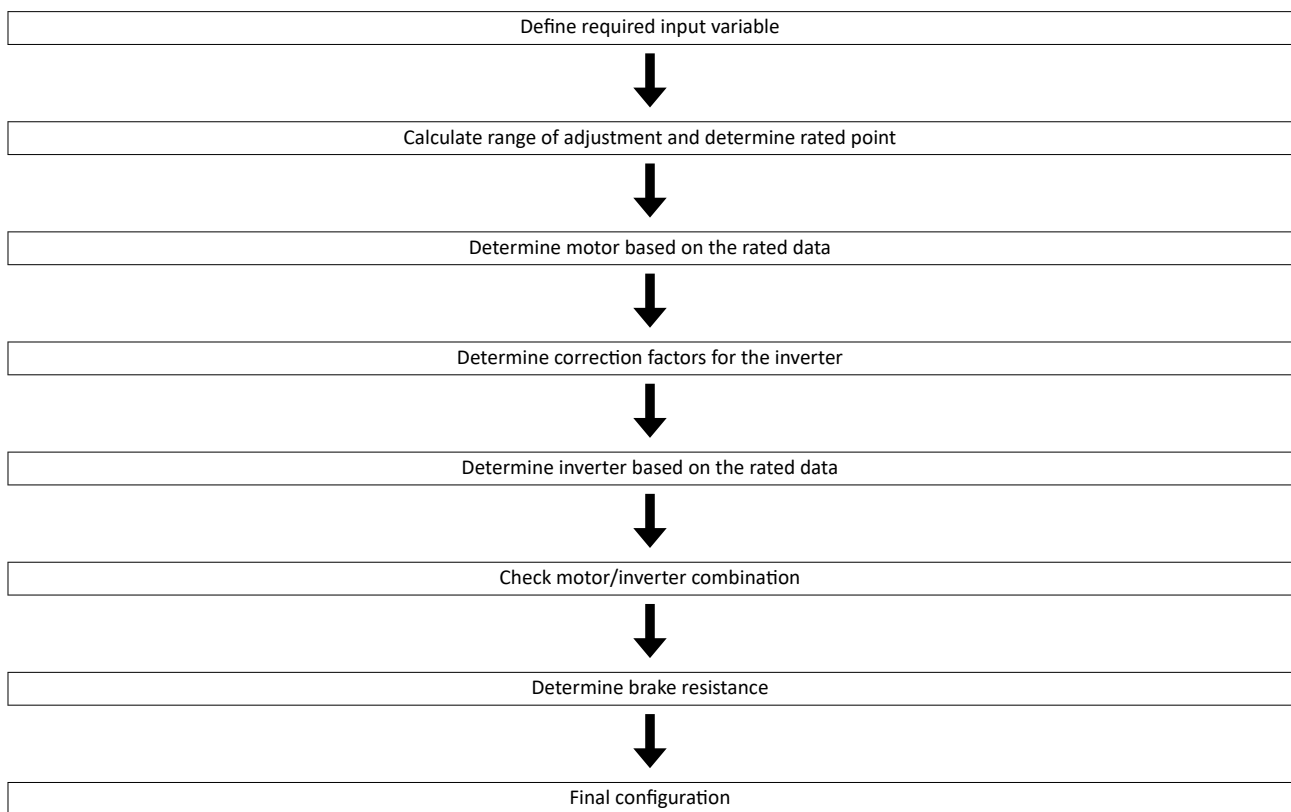

##### Define required input variables

Operating mode			S1 or S6
Max. load torque	$M_{L,max}$	Nm	
Max. load speed	$n_{L,max}$	rpm	
Min. load speed	$n_{L,min}$	rpm	
Site altitude	H	m	
Ambient temperature (inverter)	$T_U$	°C	



## Calculate range of adjustment and determine rated point

	Calculation	
Setting range	$V = \frac{n_{L,max}}{n_{L,min}}$	
	Setting range	Rated point
Motor with integral fan	$\leq 2.50$ (20 - 50 Hz) $\leq 4.35$ (20 - 87Hz) $\leq 6$ (20 - 120Hz)	50 Hz 87 Hz 120 Hz
Motor with blower	$\leq 10.0$ (5 - 50 Hz)	50 Hz
Motor with integral fan (reduced torque)	$\leq 17.4$ (5 - 87Hz) $\leq 24$ (5 - 120Hz)	87 Hz 120 Hz

## Determine motor based on the rated data

			Check
Rated torque			
Operating mode S1	$M_{rated}$	Nm	$M_N \geq \frac{M_{L,max}}{T_{H,Mot} \times T_{U,Mot}}$
Operating mode S6	$M_{rated}$	Nm	$M_N \geq \frac{M_{L,max}}{2 \times T_{H,Mot} \times T_{U,Mot}}$
Rated speed	$n_{rated}$	rpm	$n_{rated} \geq n_{L,max}$  $\frac{n_n}{V} \leq n_{L,min}$

			Note
Rated torque	$M_{rated}$	Nm	→ Rated motor data
Rated speed	$n_{rated}$	rpm	
Rated point at		Hz	→ setting range
Power factor	$\cos \varphi$		→ Rated motor data
Rated current	$I_{N,MOT}$	A	
Rated power	$P_{rated}$	kW	
Correction factor - site altitude	$T_{H,MOT}$		→ Technical motor data
Correction factor - ambient temperature	$T_{U,MOT}$		
Select motor			

## Correction factors for the inverter

Site altitude Amsl	H				
	[m]	$\leq 1000$	$\leq 2000$	$\leq 3000$	$\leq 4000$
$k_{H,INV}$		1.00	0.95	0.90	0.85
Temperature in the control cabinet	$T_U$				
	[°C]	$\leq 40$	$\leq 45$	$\leq 50$	$\leq 55$
Switching frequency					
2 or 4 kHz	$k_{TU,INV}$	1.00	1.00	0.875	0.750
8 or 16 kHz		1.00	0.875	0.750	0.625
Switching frequency with the "Light Duty" load characteristic					
2 or 4 kHz	$k_{TU,INV}$	1.00	0.875	0.750	-
8 or 16 kHz		-	-	-	-

## Determine the inverter based on the rated data

			Check
Output current			
Continuous operation	$I_{out}$	A	$I_{out} \geq I_{N,Mot} / (k_{H,INV} \times k_{TU,INV})$
Overcurrent operation cycle 15 s	$I_{out}$	A	$I_{out} \geq I_{N,Mot} \times 2 / (k_{H,INV} \times k_{TU,INV})$
Overcurrent operation cycle 180 s	$I_{out}$	A	$I_{out} \geq I_{N,Mot} \times 1.5 / (k_{H,INV} \times k_{TU,INV})$

# Information on project planning

Project planning process  
Operation in motor and generator mode



## Determine the inverter based on the rated data for the "Light Duty" load characteristic

			Check
Output current			
Continuous operation	$I_{out}$	A	$I_{out} \geq I_{N,Mot} / (k_{H,INV} \times k_{TU,INV})$
Overcurrent operation cycle 15 s	$I_{out}$	A	$I_{out} \geq I_{N,Mot} \times 1.65 / (k_{H,INV} \times k_{TU,INV})$
Overcurrent operation cycle 180 s	$I_{out}$	A	$I_{out} \geq I_{N,Mot} \times 1.25 / (k_{H,INV} \times k_{TU,INV})$

## Check motor/inverter combination

			Calculation
Motor torque	M	Nm	$M = \sqrt{\left(\frac{I_{out,INV}}{I_{N,MOT}}\right)^2 - (1 - \cos^2\varphi)} \times \frac{M_N}{\cos\varphi}$

			Check
Inverter overload capacity			$\frac{M_{L,max}}{M} \leq 1.5$

## Braking operation without additional measures

To decelerate small masses, the "DC injection brake DCB" function can be parameterised. DC-injection braking enables a quick deceleration of the drive to standstill without the need for an external brake resistor.

- A code can be used to select the braking current.
- The maximum braking torque to be realised by the DC braking current amounts to approx. 20 ... 30 % of the rated motor torque. It is lower compared to braking action in generator mode with external brake resistor.
- Automatic DC-injection braking (Auto-DCB) improves the starting performance of the motor when the operation mode without speed feedback is used.

## Final configuration

Product extensions and accessories can be found here:

▶ [Product extensions](#) 124

▶ [Accessories](#) 132

## Operation in motor and generator mode

The energy analysis differs between operation in motor mode and generator mode.

During operation in motor mode, the energy flows from the supplying mains via the inverter to the motor which converts electrical energy into mechanical energy (e. g. for lifting a load).

During operation in generator mode, the energy flows back from the motor to the inverter. The motor converts the mechanical energy into electrical energy - it acts as a generator (e. g. when lowering a load).

The drive brakes the load in a controlled manner.

The energy recovery causes a rise in the DC-bus voltage. If this voltage exceeds an upper limit, the output stage of the inverter will be blocked to prevent the device from being destroyed.

The drive coasts until the DC-bus voltage reaches the permissible value range again.



## Overcurrent operation

The inverters can be driven at higher amperages beyond the rated current if the duration of this overcurrent operation is time limited.

Two utilisation cycles of 15 s and 180 s are defined. Within these utilisation cycles, an overcurrent is possible for a certain time if afterwards an accordingly long recovery phase takes place.

### Cycle 15 s

During this operation, the inverter may be loaded for 3 s with up to 200 % of the rated current if afterwards a recovery time of 12 s with max. 75 % of the rated current is observed. A cycle corresponds to 15 s.

### Cycle 180 s

During this operation, the inverter may be loaded for 60 s with up to 150 % of the rated current if afterwards a recovery time of 120 s with max. 75 % of the rated current is observed. A cycle corresponds to 180 s.

The monitoring of the device utilization ( $I_{xt}$ ) triggers an error if the utilization value exceeds a threshold of 100 %.



The maximum output currents correspond to the switching frequencies and the overload behaviour of the inverters are given in the rated data.

In case of rotating frequencies < 10 Hz, the time-related overload behaviour may be reduced.

The graphics shows a cycle. The basic conditions given in the table (graphics field highlighted in grey) have to be complied with in order that the inverter will not be overloaded. Both cycles can be combined with each other.

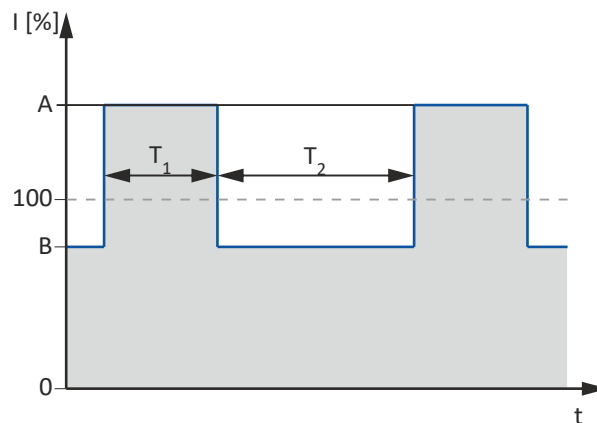

Cycle	Max. output current	Max. overload time	Max. output current during the Recovery time	Min. recovery time
	A	$T_1$	B	$T_2$
s	%	s	%	s
15	200	3	75	12
180	150	60	75	120

# Information on project planning

Control cabinet structure  
Arrangement of components



## Control cabinet structure

### Control cabinet requirements

- Protection against electromagnetic interferences
- Compliance with the ambient conditions of the installed components

### Mounting plate requirements

- The mounting plate must be electrically conductive.
  - Use zinc-coated mounting plates or mounting plates made of V2A.
  - Varnished mounting plates are unsuitable, even if the varnish is removed from the contact surfaces.
- When using several mounting plates, make a conductive connection over a large surface (e. g. using grounding strips).

### Arrangement of components

- Division into power and control areas

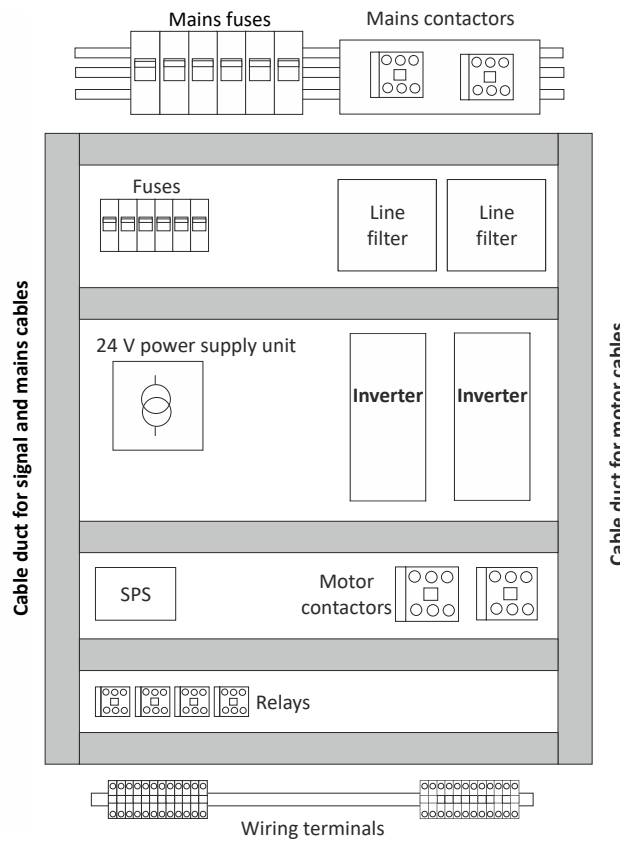

Fig. 1: Example for the ideal arrangement of components in the control cabinet





---

## Cables

### Requirements

- The cables used must correspond to the requirements at the location (e. g. EN 60204-1, UL).
- The cable cross-section must be dimensioned for the assigned fusing. Observe national and regional regulations.
- You must observe the regulations for minimum cross-sections of PE conductors. The cross-section of the PE conductor must be at least as large as the cross-section of the power connections.

### Installation inside the control cabinet

- Always install cables close to the mounting plate (reference potential), as freely suspended cables act like antennas.
- Use separated cable ducts for motor cables and control cables. Do not mix up different cable types in one cable duct.
- Route cables so that they are straight-lined to the terminals (do not form cable bundles).
- Minimize coupling capacities and coupling inductances by avoiding unnecessary cable lengths and reserve loops.
- Short-circuit unused cores to the reference potential.
- Install the cables of a 24 V DC supply (positive and negative cable) close to each other or twisted over the entire length to avoid loops.
- Before leaving the control cabinet, connect the shield of the fieldbus cable to the mounting plate in accordance with EMC requirements.

### Installation outside the control cabinet

- In the case of greater cable lengths, a greater cable distance between the cables is required.
- In the case of parallel routing (cable trays) of cables with different types of signals, the degree of interference can be minimized by using a metallic cable separator or isolated cable ducts.

### Earthing concept

- Set up the earthing system with a star topology.
- Connect all components (inverters, filters, chokes) to a central earthing point (PE rail).
- Comply with the corresponding minimum cross-sections of the cables.
- When using several mounting plates, make a conductive connection over a large surface (e. g. using grounding strips).

# Mechanical installation

## Important notes



---

## Mechanical installation

### Important notes

#### Measures for cooling during operation

- Ensure unimpeded ventilation of cooling air and outlet of exhaust air.
- If the cooling air is polluted (fluff, (conductive) dust, soot, grease, aggressive gases), take adequate countermeasures.
  - Install filters.
  - Arrange for regular cleaning of the filters.
  - Use air conditioners with hermetic separation of the inside and outside air of the control cabinet.
- If required, implement a separate air guide.

#### Mounting of the suppliers and axes

- Standard mounting: Mount the supplier to the left of the axis system.  
For mounting to the right of the axis system, the swivel hooks for the busbar system must be relocated.
- The DC infeed adapter i700 E70AZEVE001 can be connected to the left or right side of suppliers or axes.



---

## Preparation

Further data and information for mechanical mounting:

- ▶ [Control cabinet structure](#) 32
- ▶ [Dimensions](#) 113

### Mounting position

- Vertical alignment - all mains connections are at the top and the motor connections at the bottom.

### Installation clearances

- Maintain the specified installation clearances above and below to the other installations.
- Several devices of the same series can be lined up directly, regardless of the device size. No installation clearance is required between the devices.

### Mechanical installation

- The mounting location and material must ensure a durable mechanical connection.
- Do not mount onto DIN rails!
- In case of continuous vibrations or shocks use vibration dampers. If non-conductive vibration dampers are used, an EMC-compliant design must be ensured.

How to mount the inverters onto the mounting plate.

Preconditions:

- Mounting plate with conductive surface

Required:

- Tool for drilling and thread cutting
- Screwdriver
- Screw and washer assemblies or hexagon socket screws with washers.

1. Prepare mounting plate with corresponding threaded holes.
2. Fit screws and washers (if applicable).
3. Do not yet tighten the screws.
4. Mount the inverter on the prepared mounting plate via keyhole suspension.
5. Only tighten the screws hand-tight.
6. Pre-assemble further units if necessary.
7. Adjust the units.
8. Screw the units onto the mounting plate.

The inverter and any other units are mounted on the mounting plate. You can begin with the wiring.

Screw and washer assemblies or hexagon socket screws with washers are recommended..

M5 x  $\geq$  10 mm for devices up to and including 2.2 kW

M5 x  $\geq$  12 mm for devices up to and including 11 kW



## Electrical installation

### Important notes

#### **DANGER!**

Dangerous electrical voltage

During operation and up to 20 minutes after power-off, hazardous electrical voltages may be present at the connections of the product.

The leakage current against earth (PE) is  $> 3.5$  mA AC or  $> 10$  mA DC.

Possible consequences: Death or serious injury from electric shock

Protective measures

- ▶ Any work on the product must only be carried out in a deenergized state.
- ▶ Check that no voltage is present!
- ▶ After switching off the mains voltage, observe the signs on the product.
- ▶ After switching off, wait until the drive comes to a standstill.
- ▶ Implement the measures required by EN 61800-5-1 or EN 60204-1, i.e. fixed installation and standard-compliant PE connection.

#### **DANGER!**

Use of the inverter on a phase earthed mains with a rated mains voltage  $\geq 400$  V

The protection against accidental contact is not ensured without external measures.

- ▶ If protection against accidental contact according to EN 61800-5-1 is required for the control terminals of the inverters and the connections of the plugged device modules, ...
- ▶ an additional basic insulation has to be provided.
- ▶ the components to be connected have to come with a second basic insulation.

#### **WARNING!**

Dangerous electrical voltage

Device error causes an overvoltage in the system.

- ▶ For a voltage supply with DC 24 V ( $\pm 20$  %), use only a safely separated power supply unit according to the valid SELV/PELV requirements.

#### **NOTICE**

No protection against excessively high mains voltage

The mains input is not fused internally.

Possible consequences: Destruction of the product in the event of excessively high mains voltage.

- ▶ Take note of the maximum permissible mains voltage.
- ▶ On the mains supply side, use fuses to adequately protect the product against mains fluctuations and voltage peaks.



## NOTICE

Overvoltage at devices with 230-V mains connection

An impermissible overvoltage may occur if the central supply of the N conductor is interrupted if the devices are connected to a TN three-phase system.

Possible consequences: Destruction of the device

- ▶ Provide for the use of isolating transformers.

## NOTICE

The product contains electrostatic sensitive devices.

Possible consequences: Destruction of the device

- ▶ Before working in the connection area, the personnel must be free of electrostatic charge.

## NOTICE

Use of mains filters and RFI filters in IT systems

Mains filters and RFI filters from Lenze contain components that are interconnected against PE.

Possible consequences: The filters may be destroyed when an earth fault occurs.

Possible consequences: Monitoring of the IT system may be triggered.

- ▶ Do not use mains filters and RFI filters from Lenze in IT systems.
- ▶ Before using the inverter in the IT system, remove the IT screws.

## NOTICE

Overvoltage at components

In case of an earth fault in IT systems, intolerable overvoltages may occur in the plant.

Possible consequences: Destruction of the device.

- ▶ Before using the inverter in the IT system, the contact screws must be removed.
- ▶ Positions and number of the contact screws depend on the device.



When implementing machines and systems for the use in the UL/CSA scope, you have to observe the relevant special notes.

These notes are marked with "UL marking".



You have to install the devices into housings (e. g. control cabinets) to comply with valid regulations.

Stickers with warning notes must be displayed prominently and close to the device.

## Electrical isolation



Ensure a trouble-free operation:

Carry out the total wiring so that the separation of the separate potential areas is preserved.



### Preparation

#### Installation of shield connection sheet for motor cable 0.25 kW to 4 kW (optional accessories)

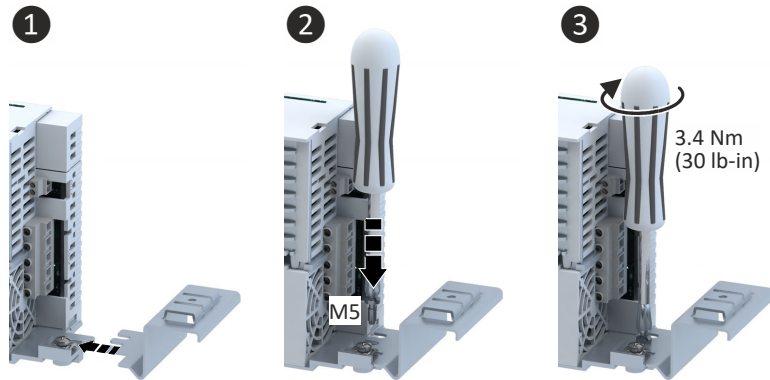

Together with the inverter, the shield connection sheet is screwed onto the mounting plate.

#### Installation of shield connection sheet for motor cable 5.5 kW (optional accessories)

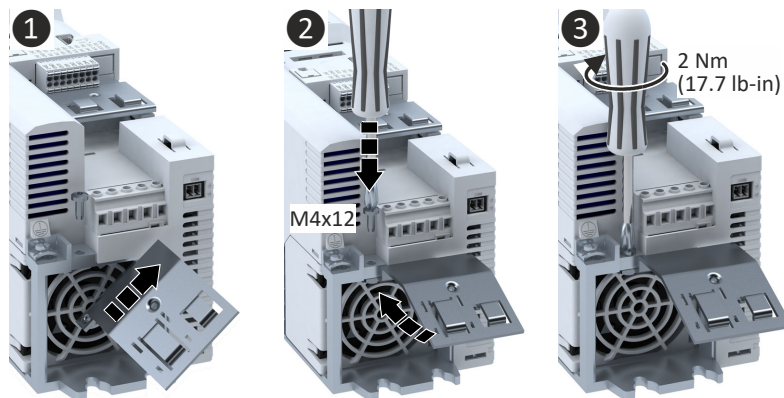

#### Installation of shield connection sheet for motor cable 7.5 kW to 11 kW (optional accessories)

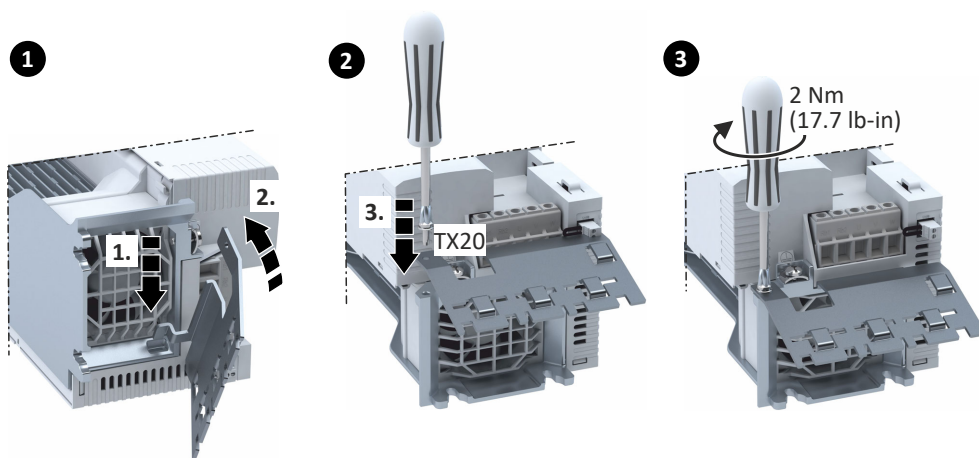

### Further data and information

- ▶ EMC-compliant installation [39](#)
- ▶ Standards and operating conditions [57](#)



## EMC-compliant installation

The drive system (inverter and drive) only complies with the directive 2014/30/EU: EMC Directive [UKCA: S.I. 2016/1091 - The Electromagnetic Compatibility Regulations 2016] if it is installed according to the guidelines for CE-typical drive systems.

These guidelines should also be followed in installations requiring FCC Part 15 or ICES 001 compliance.

The structure in the control cabinet must support the EMC-compliant installation with shielded motor cables.

- Please use sufficiently conductive shield connections.
- Connect the housing with shielding effect to the grounded mounting plate with a surface as large as possible, e. g. of inverters and RFI filters.
- Use central grounding points.

Matching accessories makes effective shielding easier.

- Motor shield plates as alternative shield connections for the motor cable
- Shield clips/shield clamps
- Metallic cable ties

The example below shows the effective wiring:

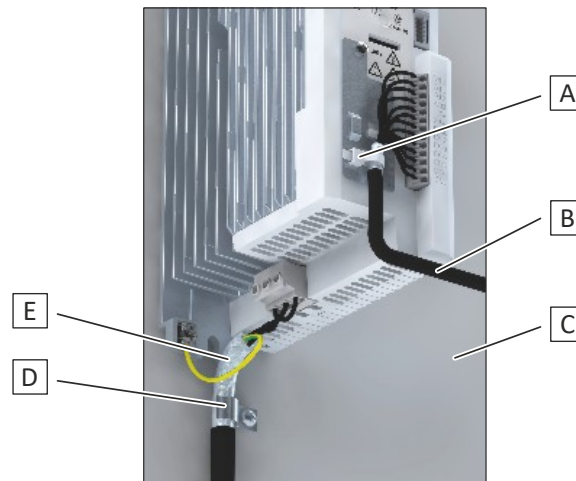

- |   |                                        |   |                                                                                                        |
|---|----------------------------------------|---|--------------------------------------------------------------------------------------------------------|
| A | Shield connection for control cables   | D | Shield connection for motor cable (alternatively: shield connection on an optional motor shield plate) |
| B | Control cable                          | E | Motor cable with low capacity                                                                          |
| C | Mounting plate with conductive surface |   |                                                                                                        |

## Mains connection

- Inverters, mains chokes, or mains filters may be connected to the mains via unshielded single cores or unshielded cables.
- Cable between line filter and inverter:

	Cable length	
	≤ 300 mm	> 300 mm
Type	unshielded twisted option	always shielded

- In DC-bus operation or DC supply, use shielded cables.

## External RFI filters

In order to meet the EMC requirements according to EN IEC 61800-3,

- an external RFI filter according to IEC EN 60939 must be used with certain inverters and
- one or both screws marked "IT" on the product must be removed when using certain external RFI filters.

More information can be found under: [▶ Technical data](#) 57

# Electrical installation

EMC-compliant installation  
Motor cable



## Motor cable

EMC-compliant installation must be carried out with shielded low-capacitance motor cables.

### Capacitance per unit length

- Cable cross-section  $\leq 2.5 \text{ mm}^2$  ( $\geq$  AWG 14): C-core-core/C-core-shield  $<75/150 \text{ pF/m}$
- Cable cross-section  $\leq 4 \text{ mm}^2$  ( $\geq$  AWG 12): C-core-core/C-core-shield  $<150/300 \text{ pF/m}$

### Braid

- Only use motor cables with braids made of tinned or nickel-plated copper.
- Shields made of steel braids are not suitable.
- The overlap rate of the braid must be at least 70 % with an overlap angle of  $90^\circ$ .

### Shield connection

- Apply shielding over a large area.
- Shield mounting with metal cable tie or conductive clip.
- The following is suitable for connecting the shield:
  - The mounting plate
  - A central grounding rail
  - A shield plate, if necessary, optional [▶ Shield mounting kit 140](#)

### Cable for motor temperature monitoring

- Shield the cable for motor temperature monitoring (PTC or thermal contact) and install it separately from the motor cable.
- In Lenze system cables, the cable for the brake control is integrated into the motor cable. If this cable is not required, it can also be used to connect the motor temperature monitoring up to a length of 50 m.

### Measures on the motor

- Connect the shield with PE over a large area at the terminal box of the motor, e.g. via a metallic EMC cable gland.
- For motors with plug connectors, the large-area shield connection is ensured via the plug connection.

### Further supporting measures

- Route the motor cable separately from the mains cables and control cables.
- Lay the motor cable so that it only crosses mains cables and control cables at right angles.
- Do not disconnect the motor cable.
- If the motor cable must be disconnected (e.g. by chokes, contactors, or terminals):
  - Install the shield of the motor cable directly before and behind the point of separation to the mounting plate with a large surface.
  - The unshielded cable ends must not be longer than 100 mm.
  - Mount the separating component at least 100 mm away from other components.

### Control cables

- Install the cables so that no induction-sensitive loops arise.
- Distance of shield connections of control cables to shield connections of motor cables and DC cables:
  - At least 50 mm
- Control cables for analog signals:
  - Must always be shielded
  - Connect the shield on one side of the inverter
- Control cables for digital signals:

	Cable length		
	< ca. 5 m	ca. 5 m ... ca. 30 m	> ca. 30 m
Type	unshielded option	unshielded twisted option	always shielded connected on both sides





---

## Fieldbus cables, networks

Please observe the following recommendations for trouble-free operation, especially in the event of Ethernet-based networks.

- Cables and wiring must meet the specifications and requirements of the network being used to allow reliable operation of the network in typical installations. In this context, also observe the recommendations for action of the respective user organization.
- Lay network cables separately from power cables. Maintain as large a distance as possible to the motor cables which are subject to interference.
- To avoid compensating currents via the shielding of the network cable, install an independent, low-resistance equipotential bonding over the shortest possible distance parallel to the network cable. This applies in particular to long cables.
- Observe bending radii according to manufacturer information. Minimum bending radii of 10 x cable diameter or 20 x diameter for frequent manipulation of the cables are standard.
- Fix longer cables 30 cm after the connection point.
- Before leaving the control cabinet, connect the shield of the network cable with the equipotential bonding system (e. g. mounting plate) on a large surface.

Patch cable/CAT5 cables:

- Cables must comply with CAT5 and be suitable for  $\geq 10$  Mbps.
- CAT5 cables according to specification establish the shield connection via the RJ45 plug connection. Additional shield connections are not required.
- Patch cables of 25 cm length are suitable for the network connection of inverters  $\leq 4$  kW installed side by side. When wiring from right to left, a sufficient bending radius can be maintained.
- Only certified, tested and fully assembled patch cables from well-known manufacturers are recommended.

RJ45 plug connections:

- RJ45 plug connections only function properly if they are not subjected to mechanical stress or lateral forces.
- For all communication modules of the i-series, the connection of the cable shielding at the RJ45 sockets is carried out as follows:
  - At the first RJ45 socket, the shielding is directly connected to functional earth (FE).
  - At the second RJ45 socket, the shielding is connected to functional earth (FE) via an RC element.

This measure prevents potential equalization currents and the resulting interference effects (see also IEC 61158-2, section 11.8.7).

**Note:** High-frequency interference is dissipated via the low-impedance capacitor to functional earth (FE), but for low-frequency signals this system has a high loop impedance. Measuring systems that use low impedance test signals therefore indicate too high impedance values for the shielding at the second RJ45 socket

# Electrical installation

EMC-compliant installation

Detecting and eliminating EMC interferences



## Detecting and eliminating EMC interferences

Trouble	Cause	Remedy
Interferences of analog setpoints of your own or other devices and measuring systems	Unshielded motor cable has been used	Use shielded motor cable
	Shield contact is not extensive enough	Carry out optimal shielding as specified
	Shield of the motor cable is interrupted, e. g. by terminal strips, switches etc.	<ul style="list-style-type: none"> <li>Separate components from other component parts with a minimum distance of 100 mm</li> <li>Use motor chokes or motor filters</li> </ul>
	Additional unshielded cables inside the motor cable have been installed, e. g. for motor temperature monitoring	Install and shield additional cables separately
Conducted interference level is exceeded on the supply side	Too long and unshielded cable ends of the motor cable	Shorten unshielded cable ends to max. 40 mm
	Terminal strips for the motor cable are directly located next to the supply terminals	Spatially separate the terminal strips for the motor cable from mains terminals and other control terminals with a minimum distance of 100 mm
	Mounting plate varnished	Optimize PE connection: <ul style="list-style-type: none"> <li>Remove varnish</li> <li>Use zinc-coated mounting plate</li> </ul>
Malfunctions of the fieldbus communication or exceedance of the permissible interference levels	HF short circuit	Check cable routing
	Shield contact is not extensive enough	Before leaving the control cabinet, connect the shield of the fieldbus cable with the equipotential bonding system (e. g. mounting plate) on a large surface.
	Shield connection on the inverter only	
	Shield of fieldbus cable connected on one side only	Shield connection on both sides



---

## Connection according to UL

### Important notes

#### **WARNING!**

- ▶ **UL marking**
  - ▶ The integral solid state short circuit protection included in the inverter does not provide branch circuit protection. Branch circuit protection must be provided in accordance with the National Electrical Code / Canadian Electrical Code and any additional local codes.
  - ▶ **Marquage UL**
  - ▶ La protection statique intégrée contre les courts-circuits n'offre pas la même protection que le dispositif de protection du circuit de dérivation. Un tel dispositif doit être fourni, conformément au National Electrical Code / Canadian Electrical Code et aux autres dispositions applicables au niveau local.
- 

#### **WARNING!**

- ▶ **UL marking**
  - ▶ Use 75 °C copper wire only, except for control circuits.
  - ▶ **Marquage UL**
  - ▶ Utiliser exclusivement des conducteurs en cuivre 75 °C, sauf pour la partie commande.
- 

#### **WARNING!**

- ▶ **UL marking**
  - ▶ Suitable for motor group installation or use on a circuit capable of delivering not more than the RMS symmetrical amperes (SCCR) of the drive at its rated voltage.
  - ▶ Approved fusing is specified in SCCR tables below.
  - ▶ **Marquage UL**
  - ▶ Convient pour l'utilisation sur une installation avec un groupe de moteurs ou sur un circuit capable de fournir au maximum une valeur de courant efficace symétrique en ampères à la tension assignée de l'appareil.
  - ▶ Les dispositifs de protection adaptés sont spécifiés dans les SCCR tableaux suivants.
- 

#### **WARNING!**

- ▶ **UL marking**
  - ▶ The opening of the Branch Circuit Protective Device may be an indication that a fault has been interrupted. To reduce the risk of fire or electric shock, current carrying parts and other components of the controller should be examined and replaced if damaged. If burnout of the current element of an overload relay occurs, the complete overload relay must be replaced.
  - ▶ **Marquage UL**
  - ▶ Le déclenchement du dispositif de protection du circuit de dérivation peut être dû à une coupure qui résulte d'un courant de défaut. Pour limiter le risque d'incendie ou de choc électrique, examiner les pièces porteuses de courant et les autres éléments du contrôleur et les remplacer s'ils sont endommagés. En cas de grillage de l'élément traversé par le courant dans un relais de surcharge, le relais tout entier doit être remplacé.
-

# Electrical installation

Connection according to UL  
Fusing data



## NOTICE

### ► UL marking

► Internal overload protection rated for 125 % of the rated FLA.

### ► Marquage UL

► Protection contre les surcharges conçue pour se déclencher à 125 % de l'intensité assignée à pleine charge.

## Fusing data

### Branch Circuit Protection (BCP) with standard fuses or circuit breakers

#### Short Circuit Current Ratings (SCCR) with Standard Fuses or Circuit Breaker

(Tested per UL61800-5-1, reference UL file E132659)

These devices are suitable for motor group installation when used with Standard Fuses or Circuit Breaker. For single motor installation, if the fuse value indicated is higher than 400 % of the motor current (FLA), the fuse value has to be calculated. If the value of the fuse is below two standard ratings, the nearest standard ratings less than the calculated value shall apply.

Inverter			Standard Fuses (UL248)			Circuit Breaker (UL489)			
Mains	Rated power		Max. SCCR	Max. rated current	Class	Max. SCCR	Max. rated current	Min. cabinet dimensions	
	kW	hp						kA	A
230 V, 1-ph	0.25	0.33	65	15	CC, CF, J, T	65	15	0.042	1.48
230 V, 1-ph	0.37	0.5	65	15	CC, CF, J, T	65	15	0.042	1.48
230 V, 1-ph	0.55	0.75	65	30	CC, CF, J, T	65	30	0.042	1.48
230 V, 1-ph	0.75	1	65	30	CC, CF, J, T	65	30	0.042	1.48
230 V, 1-ph	1.1	1.5	65	30	CC, CF, J, T	65	30	0.042	1.48
230 V, 1-ph	1.5	2	65	30	CC, CF, J, T	65	30	0.042	1.48
230 V, 1-ph	2.2	3	65	30	CC, CF, J, T	65	30	0.042	1.48
230 V, 1/3-ph	0.25	0.33	65	15	CC, CF, J, T	65	15	0.042	1.48
230 V, 1/3-ph	0.37	0.5	65	15	CC, CF, J, T	65	15	0.042	1.48
230 V, 1/3-ph	0.55	0.75	65	30	CC, CF, J, T	65	30	0.042	1.48
230 V, 1/3-ph	0.75	1	65	30	CC, CF, J, T	65	30	0.042	1.48
230 V, 1/3-ph	1.1	1.5	65	30	CC, CF, J, T	65	30	0.042	1.48
230 V, 1/3-ph	1.5	2	65	30	CC, CF, J, T	65	30	0.042	1.48
230 V, 1/3-ph	2.2	3	65	30	CC, CF, J, T	65	30	0.042	1.48
230 V, 3-ph	4	5	100	40	CC, CF, J, T	65	40	0.042	1.48
230 V, 3-ph	5.5	7.5	100	40	CC, CF, J, T	65	40	0.042	1.48
480 V, 3-ph	0.37	0.5	65	15	CC, CF, J, T	65	15	0.042	1.48
480 V, 3-ph	0.55	0.75	65	15	CC, CF, J, T	65	15	0.042	1.48
480 V, 3-ph	0.75	1	65	15	CC, CF, J, T	65	15	0.042	1.48
480 V, 3-ph	1.1	1.5	65	15	CC, CF, J, T	65	15	0.042	1.48
480 V, 3-ph	1.5	2	65	15	CC, CF, J, T	65	15	0.042	1.48
480 V, 3-ph	2.2	3	65	15	CC, CF, J, T	65	15	0.042	1.48
480 V, 3-ph	3	4	65	35	CC, CF, J, T	65	25	0.042	1.48
480 V, 3-ph	4	5	65	35	CC, CF, J, T	65	25	0.042	1.48
480 V, 3-ph	5.5	7.5	65	30	CC, CF, J, T	65	25	0.042	1.48
480 V, 3-ph	7.5	10	65	40	CC, CF, J, T	65	40	0.042	1.48
480 V, 3-ph	11	15	65	40	CC, CF, J, T	65	40	0.042	1.48



## Short Circuit Current Ratings (SCCR) with Semiconductor Fuses

(Tested per UL61800-5-1, reference UL file E132659)

These devices are suitable for standard installation when used with Semiconductor Fuses. For single motor installation, if the fuse value indicated is higher than 400 % of the motor current (FLA), the fuse value has to be calculated. If the value of the fuse is below two standard ratings, the nearest standard ratings less than the calculated value shall apply.

Mains	Inverter		Alternate Fuse (Semiconductor Fuse)	
	Rated power		Max. SCCR	Max. rated current
	kW	hp	kA	A
230 V, 1-ph	0.25	0.33	100	16
230 V, 1-ph	0.37	0.5	100	16
230 V, 1-ph	0.55	0.75	100	40
230 V, 1-ph	0.75	1	100	40
230 V, 1-ph	1.1	1.5	100	50
230 V, 1-ph	1.5	2	100	50
230 V, 1-ph	2.2	3	100	50
230 V, 1/3-ph	0.25	0.33	100	16
230 V, 1/3-ph	0.37	0.5	100	16
230 V, 1/3-ph	0.55	0.75	100	40
230 V, 1/3-ph	0.75	1	100	40
230 V, 1/3-ph	1.1	1.5	100	40
230 V, 1/3-ph	1.5	2	100	40
230 V, 1/3-ph	2.2	3	100	40
230 V, 3-ph	4	5	100	50
230 V, 3-ph	5.5	7.5	100	50
480 V, 3-ph	0.37	0.5	100	6
480 V, 3-ph	0.55	0.75	100	16
480 V, 3-ph	0.75	1	100	16
480 V, 3-ph	1.1	1.5	100	16
480 V, 3-ph	1.5	2	100	16
480 V, 3-ph	2.2	3	100	20
480 V, 3-ph	3	4	100	40
480 V, 3-ph	4	5	100	40
480 V, 3-ph	5.5	7.5	100	50
480 V, 3-ph	7.5	10	100	63
480 V, 3-ph	11	15	100	80

# Electrical installation

Connection according to UL  
Fusing data



## Approved manufacturers for semiconductor fuses

Manufacturer	Max. rated current	Designation
	A	
Eaton/Bussmann	6	FWP-6A14F
	16	FWP-15B, FWP-15A14F
		170M1309, 170M1359, 170M1409
	20	FWP-20B, FWP-20A14F
		170M1310, 170M1360, 170M1410
	40	FWP-40A22F, FWP-40B, FWP-40A14F, FWP-40A
		170M1313, 170M1363, 170M1413
	50	FWP-50A22F, FWP-50B, FWP-50A14F, FWP-50A
170M1314, 170M1364, 170M1414		
63	FWP-63A22F, FWP-60B, FWP-60A	
	170M1315, 170M1365, 170M1415	
80	FWP-80A22F, FWP-80B, FWP-80A	
	170M1316, 170M1366, 170M1416	
Littelfuse	40	L70QS040
	50	L70QS050
	63	L70QS060
	80	L70QS080
Mersen	6	A70QS6-14F, A70QS6-14FI
	16	A60Q15-2
		A70QS16-14F, A70QS16-14FI, A70QS15-22F, A70QS15-22FI
	20	A70QS20-14F, A70QS20-14FI, A70QS20-22F, A70QS20-22FI
	40	A70QS40-14F, A70QS40-14FI, A70QS40-22F, A70QS40-22FI, A70QS40-4
	50	A70QS50-22F, A70QS50-14F, A70QS50-14FI, A70QS50-22FI, A70QS50-4
	63	A70QS63-22F, A70QS63-22FI, A70QS60-4
80	A70QS80-22F, A70QS80-4, A70QS80-22FI	
SIBA	16	5020106.16, 5020206.16
	20	5020106.20, 5020206.20
	40	5020106.40, 5020206.40
	50	5020106.50, 5020206.50
	63	2029220.63
		5020106.63, 5020206.63
80	2029220.80	



### **Mains connection**

The following should be considered for the mains connection of inverters:

Single inverters are connected directly to the **AC system** or via upstream filters. RFI filters are already integrated in many inverters. Depending on the requirements, mains chokes or mains filters can be used.

This enables the energy exchange in phases with operation in generator and motor mode of several drives in the network.

The technical data informs about the possible applications in the given groups. In the dimensioning, data and further notes have to be observed.

# Electrical installation

Mains connection

1-phase mains connection 230/240 V



## 1-phase mains connection 230/240 V

The connection plan is valid for the inverters i510-Cxxx/230-1.

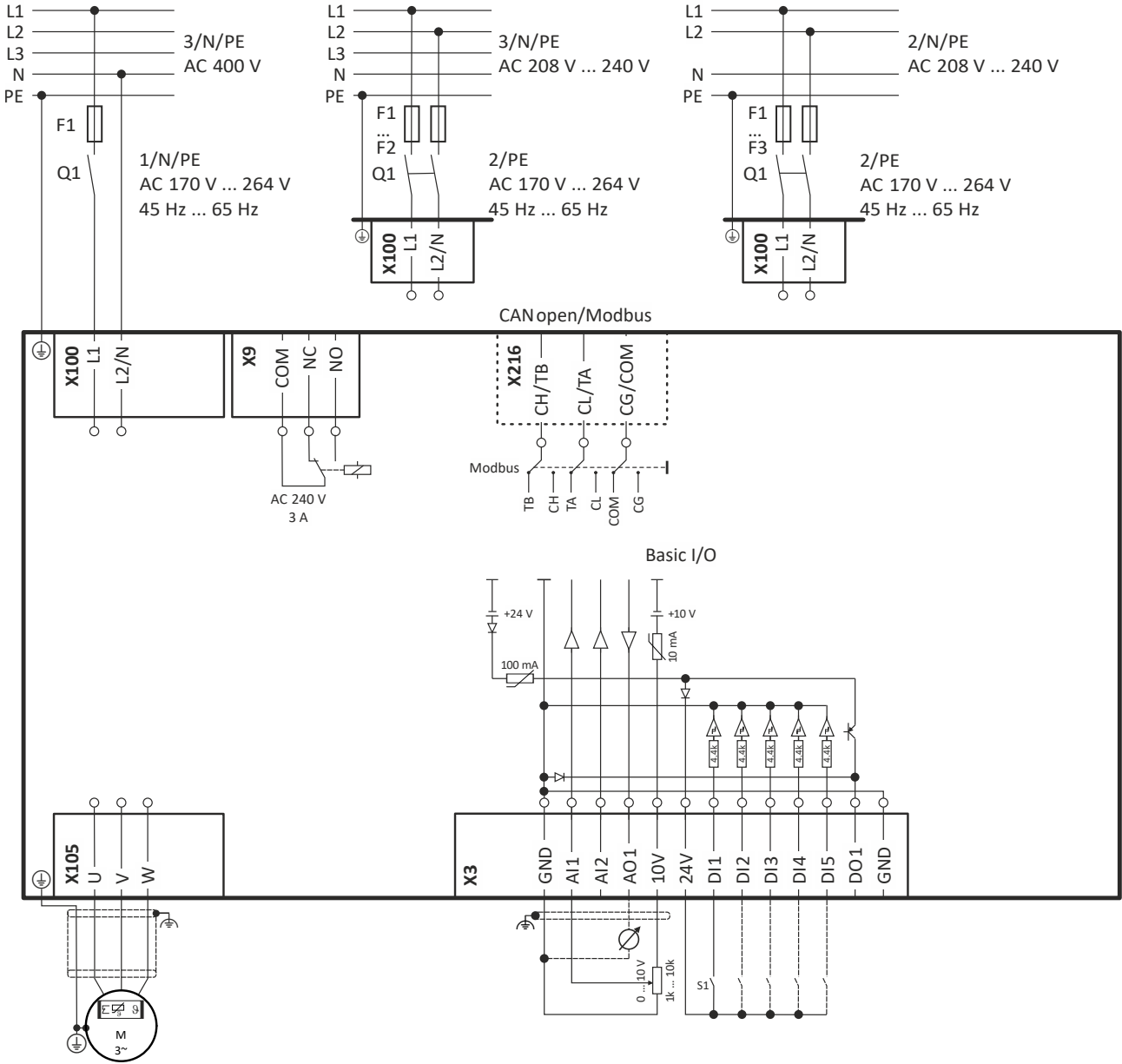

Fig. 2: Wiring example

- S1 Start/Stop
- Fx Fuses

- Q1 Mains contactor
- Dashed line = options





The connection plan is valid for the inverters i510-Cxxx/230-2.



Inverters i510-Cxxx/230-2 do not have an integrated RFI filter in the AC mains supply.

In order to meet the EMC requirements according to EN IEC 61800-3, an external EMC filter according to IEC EN 60939 must be used.

The user must verify that the conformity with EN IEC 61800-3 is fulfilled.

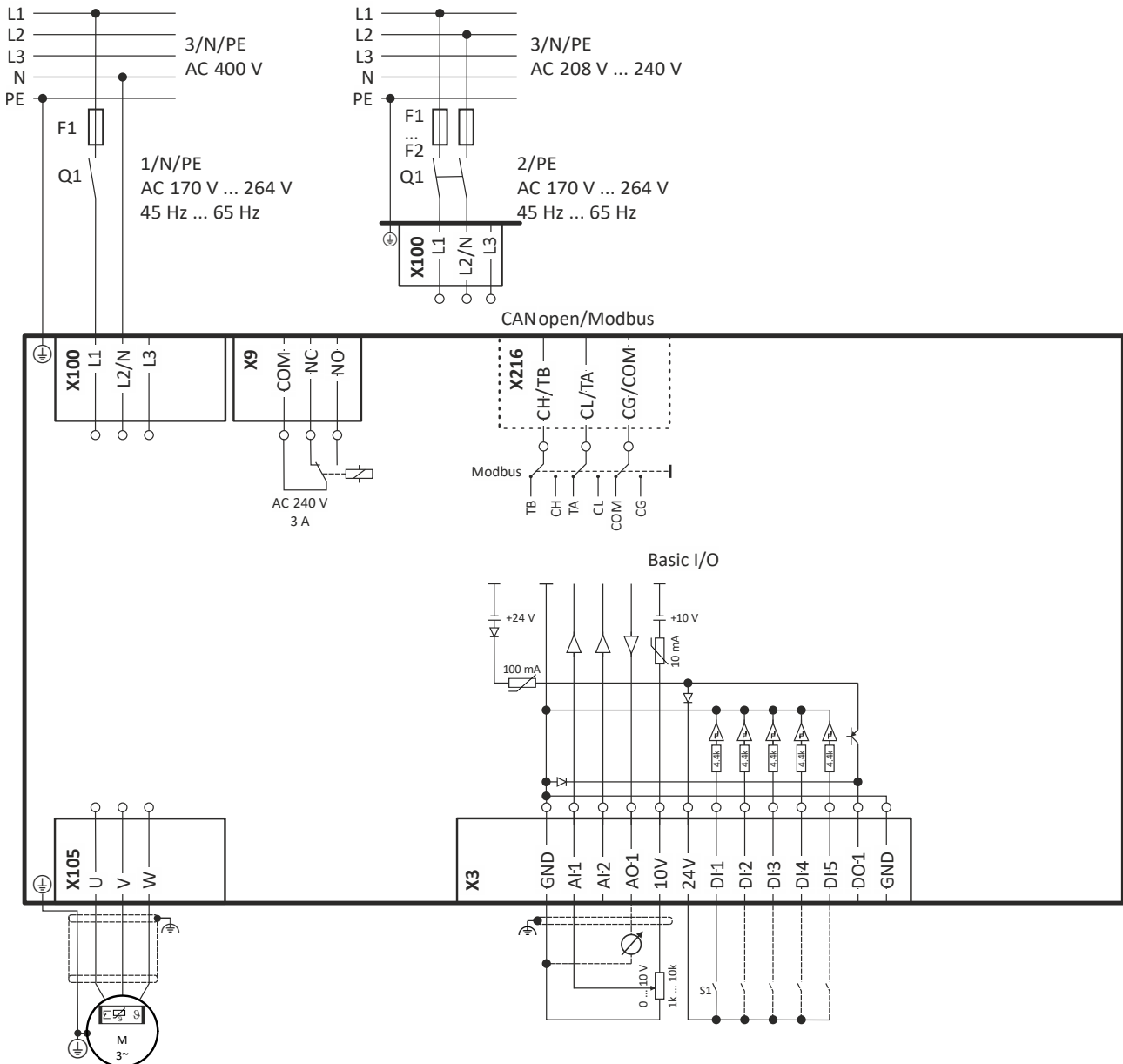

Fig. 3: Wiring example

S1 Start/Stop  
Fx Fuses

Q1 Mains contactor  
-- Dashed line = options

# Electrical installation

Mains connection  
3-phase mains connection 230/240 V



## 3-phase mains connection 230/240 V

The connection plan is valid for the inverters i510-Cxxx/230-3 and i510-Cxxx/230-2.



Inverters i510-Cxxx/230-3 and i510-Cxxx/230-2 do not have an integrated RFI filter in the AC mains supply.

In order to meet the EMC requirements according to EN IEC 61800-3, an external EMC filter according to IEC EN 60939 must be used.

The user must verify that the conformity with EN IEC 61800-3 is fulfilled.

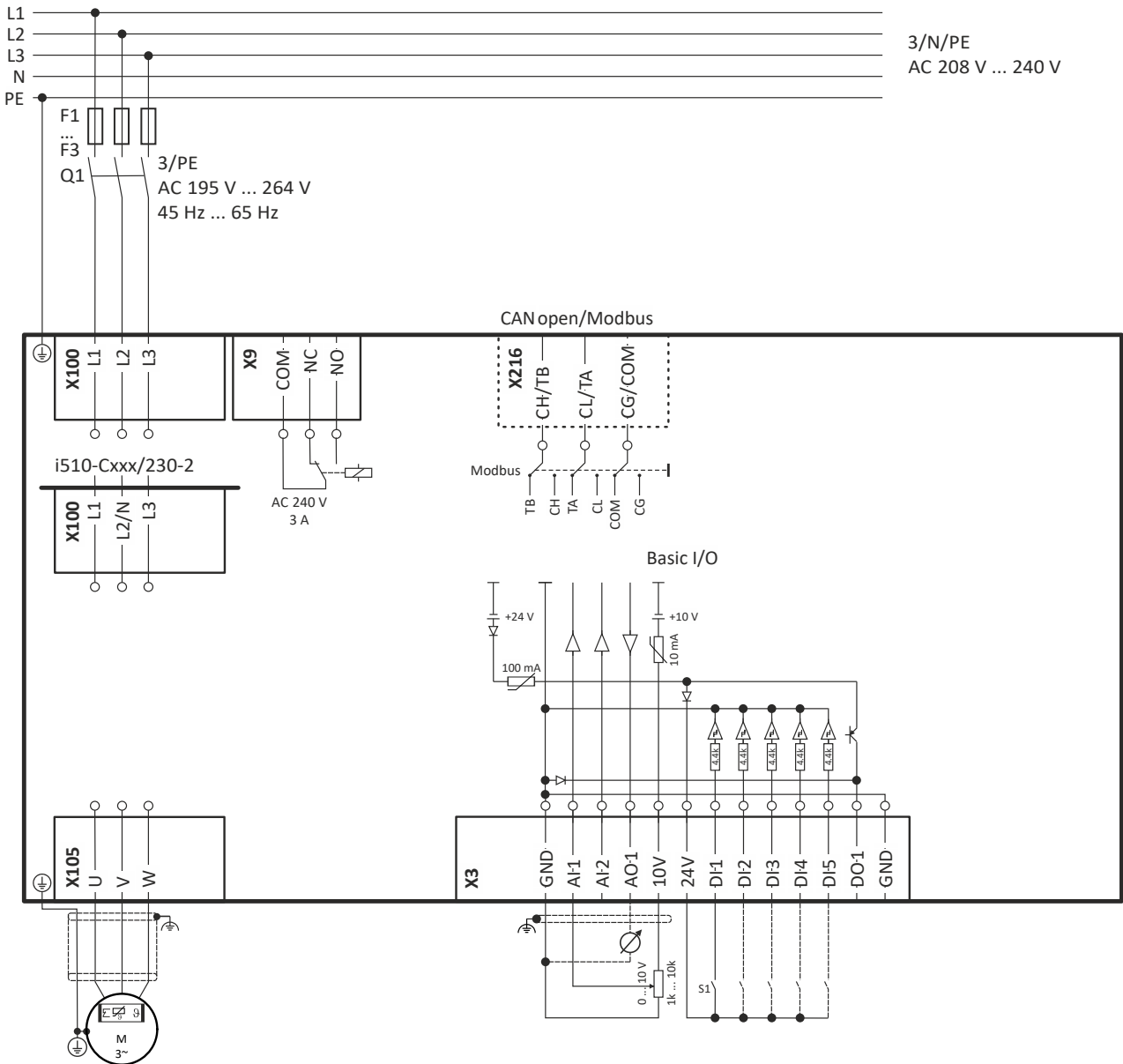

Fig. 4: Wiring example

S1 Start/Stop  
Fx Fuses

Q1 Mains contactor  
--- Dashed line = options



# Electrical installation

Mains connection  
3-phase mains connection 400 V

## 3-phase mains connection 400 V

The connection plan is valid for the inverters i510-Cxxx/400-3.

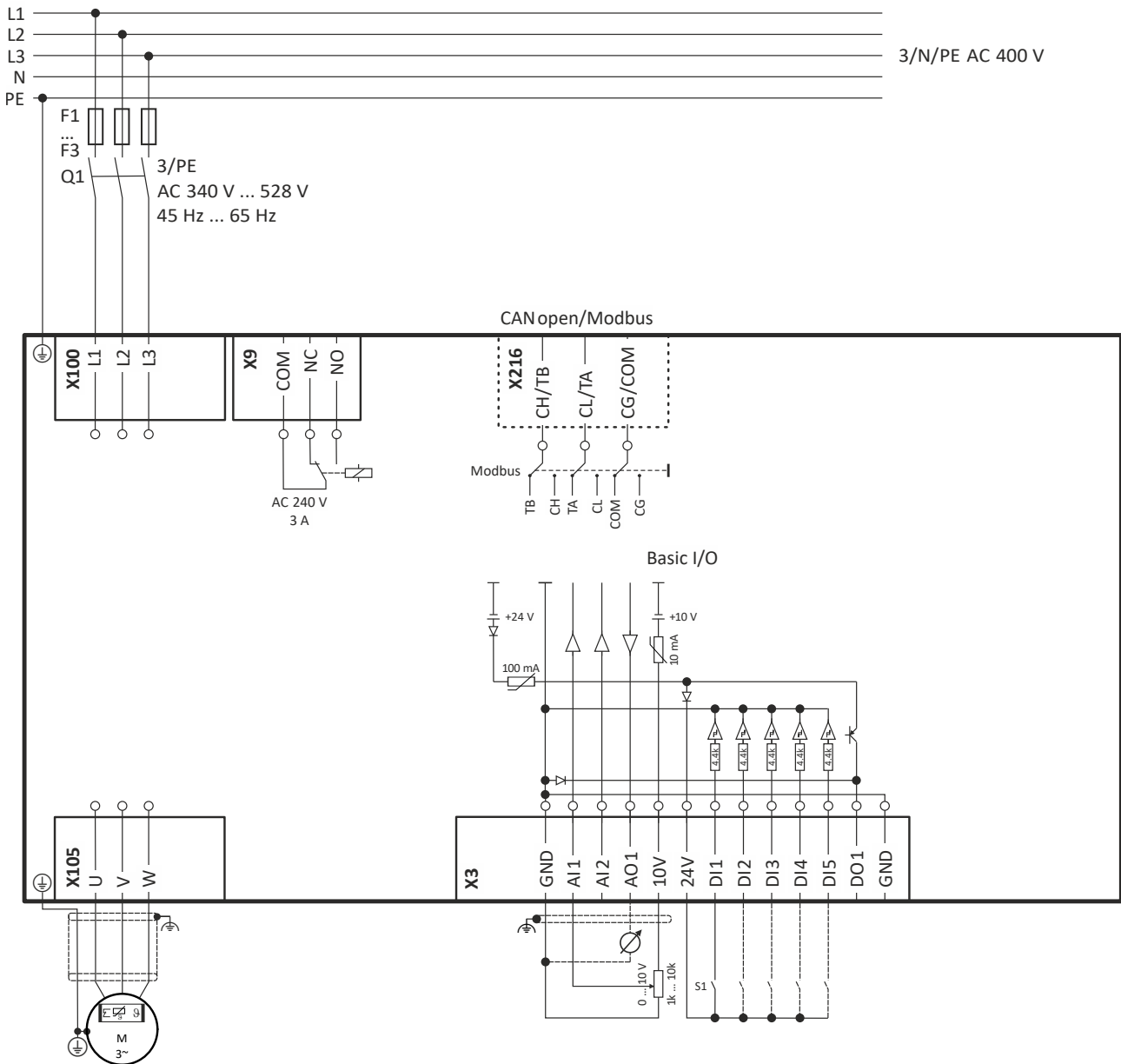

Fig. 5: Wiring example

S1 Start/Stop  
Fx Fuses

Q1 Mains contactor  
--- Dashed line = options

# Electrical installation

Mains connection  
3-phase mains connection 480 V



## 3-phase mains connection 480 V

The connection plan is valid for the inverters i510-Cxxx/400-3.

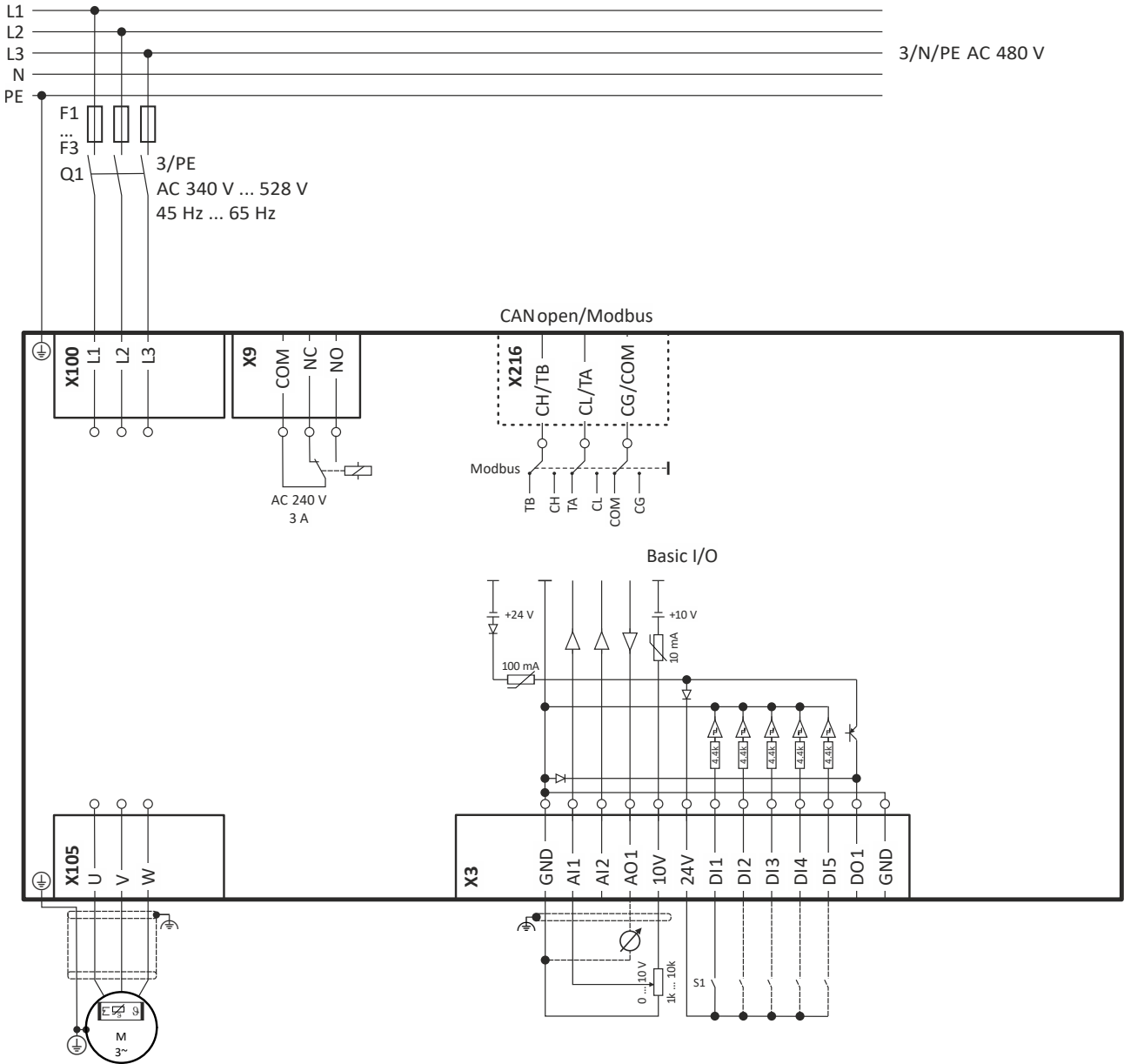

Fig. 6: Wiring example

S1 Start/Stop  
Fx Fuses

Q1 Mains contactor  
--- Dashed line = options



---

### Motor connection

#### Motor cable lengths

- The rated data for the motor cable length must be observed.
- Keep the motor cable as short as possible as this has a positive effect on the drive behaviour and the EMC.
- Several motors connected to an inverter form a group drive.  
In case of group drives, the resulting motor cable length  $l_{res}$  is relevant:

$$l_{res} [m] = (l_1 + l_2 + l_3 \dots l_i) \cdot \sqrt{i}$$

$l_{res}$       Resulting length of the motor cables

$l_x$       Length of the single motor cable

$i$       Number of the single motor cables

#### Switching in the motor cable



---

Switching on the motor side of the inverter is permissible:

For safety shutdown (emergency stop).

In case several motors are driven by one inverter (only in V/f operating mode).

Please note the following:

The switching elements on the motor side must be dimensioned for with the maximum occurring load.

---

# Electrical installation

Connection to the IT system



## Connection to the IT system

### NOTICE

Internal components have earth/ground potential

Possible consequence: The monitoring devices of the IT system will be triggered.

- ▶ Upstream an isolation transformer.
- ▶ Before connection to an IT system be absolutely sure to remove the screws labeled with "IT" on the product.

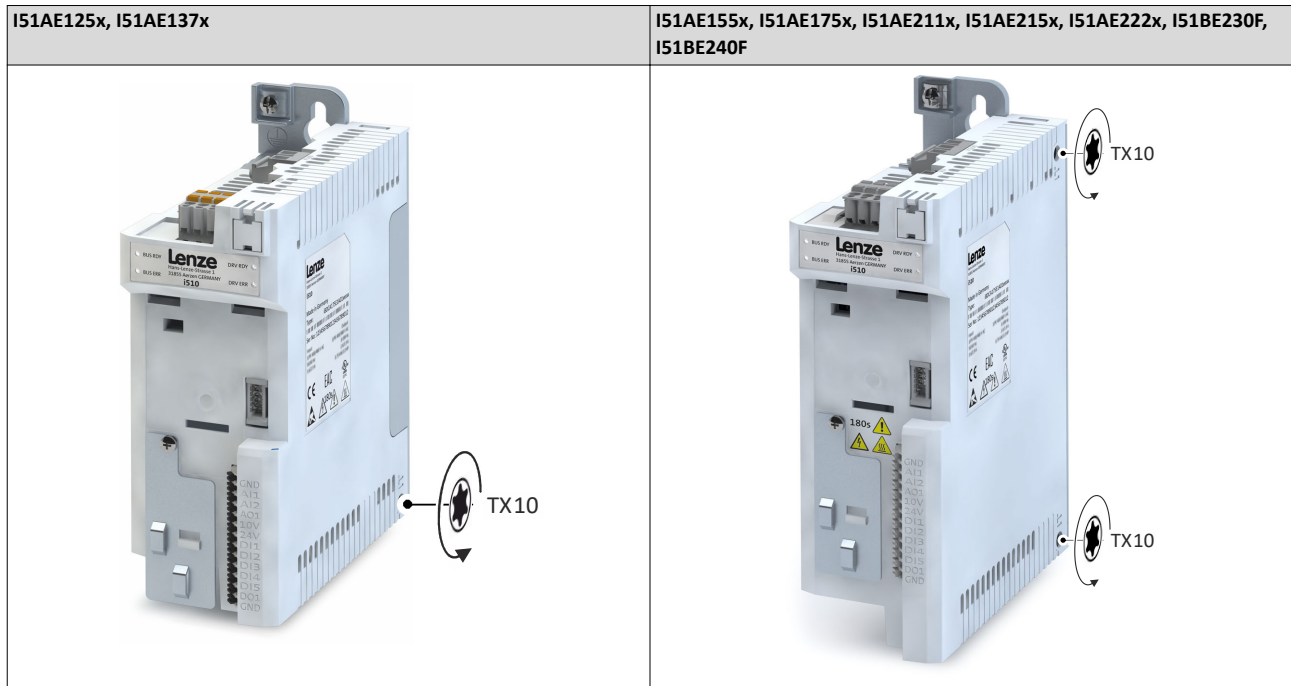



I51AE240C, I51AE255x, I51BE275F, I51BE311F

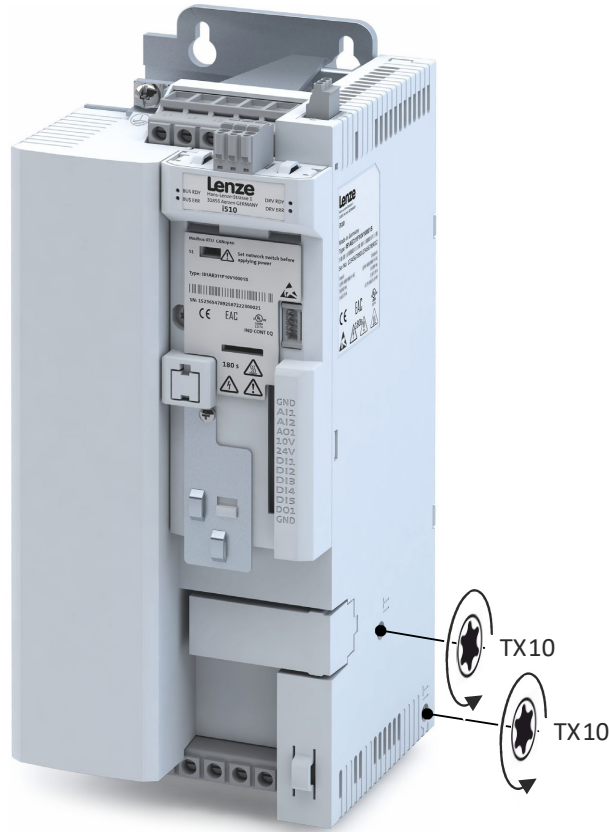

## Control connections



In case of long cables and/or high interference the effect of the shielding can be improved. To do this, connect the shield of cables for the analog inputs and outputs at one end of the cable via a capacitor with PE potential (e. g. 10 nF/ 250 V).

Connection description			Control terminals	Relay output
Connection			X3	X9
Connection type			Non-pluggable	Pluggable
Max. Cable cross-section		mm <sup>2</sup>	1.5	1.5
Max. Cable cross-section		AWG	16	14
Min. Cable cross-section		mm <sup>2</sup>	0.5	0.5
Min. Cable cross-section		AWG	22	22
Stripping length		mm	9	6
Stripping length		in	0.35	0.2
Required tool			Screwdriver 0.4 x 2.5	

# Electrical installation

Networks  
CANopen/Modbus



## Networks



When planning networks, consider the recommendations listed in the chapter "EMC-compliant installation" for low-interference operation, especially of Ethernet-based networks.

EMC-compliant installation → [Fieldbus cables, networks](#) 41

## CANopen/Modbus



The network must be terminated with a 120 Ω resistor at the physically first and last node.

Connect resistor to terminals CH/TB and CL/TA.

## Typical topologies

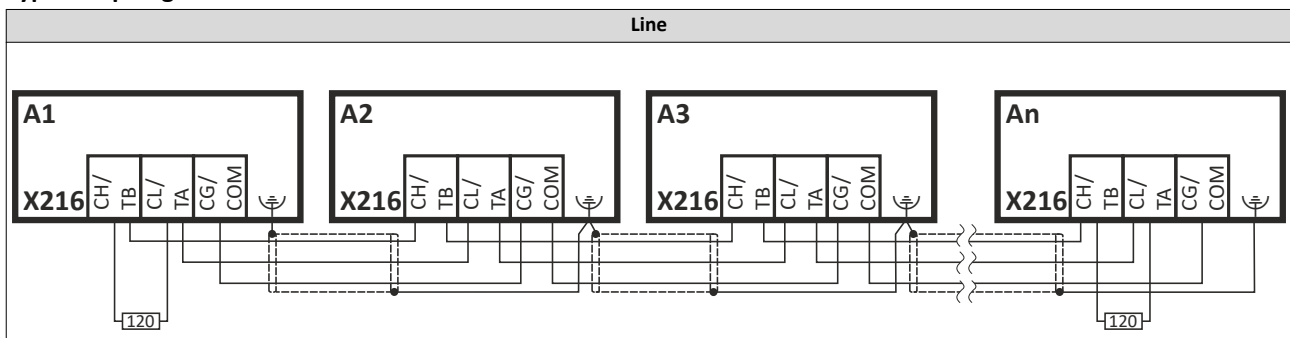

Connection description		CANopen/Modbus	
Connection		X216	
Connection type		Pluggable	
Max. Cable cross-section	mm <sup>2</sup>	2.5	
Max. Cable cross-section	AWG	12	
Stripping length	mm	10	
Stripping length	in	0.39	
Required tool		Screwdriver 0.4 x 2.5	

## Basic network settings

1. Select network CANopen or Modbus using the switch on the front of the inverter.

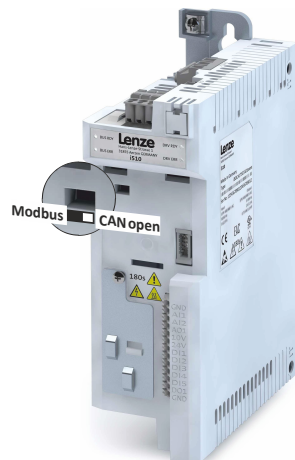

2. Set node address and baud rate via the corresponding parameters.





## Technical data

### Standards and operating conditions

#### Conformities and approvals

Conformities			
CE	2009/125/EC		Ecodesign Directive
	2011/65/EU		RoHS Directive
	2014/30/EU		EMC Directive (reference: CE-typical drive system)
	2014/35/EU		Low-Voltage Directive
EAC	TP TC 020/2011		Eurasian conformity: Electromagnetic compatibility of technical means
	TR TC 004/2011		Eurasian conformity: Safety of low voltage equipment
UKCA	S.I. 2008/1597		The Supply of Machinery (Safety) Regulations 2008
	S.I. 2012/3032		The Restriction of the Use of Certain Hazardous Substances in Electrical and Electronic Equipment Regulations 2012
	S.I. 2016/1091		The Electromagnetic Compatibility Regulations 2016
	S.I. 2021/745		The Ecodesign for Energy-Related Products and Energy Information Regulations 2021
Approvals			
UL	UL 61800-5-1		File No. E132659 For USA and Canada (requirements of the CSA 22.2 No. 274)

#### Protection of persons and device protection

Degree of protection			Data applies to operationally ready mounted state and not in wire range of terminals
EN	EN IEC 60529	IP20	In the connection area of mains and motor partly IP10
NEMA	NEMA 250	Type 1	Protection against accidental contact only
Insulation resistance			
Overvoltage category	EN IEC 61800-5-1	II	>2000 m amsl
		III	0 ... 2000 m amsl
Isolation of control circuits			
	EN IEC 61800-5-1	Safe mains isolation	Double/reinforced insulation
Leakage current			
AC	EN IEC 61800-5-1	> 3.5 mA	Observe regulations and safety instructions!
DC		> 10 mA	
Starting current			
		≤ 3 x rated mains current	
Protective measures			
Earth fault strength			Earth-fault protected depending on operating status
Motor stalling protection			
Short-circuit strength			
Overvoltage resistance			
Motor overtemperature			I <sup>2</sup> t monitoring

# Technical data

Standards and operating conditions  
EMC data



## EMC data

Operation on public supply systems			The machine or system manufacturer is responsible for compliance with the requirements for the machine/system!
< 1 kW	EN IEC 61000-3-2	With mains choke	
> 1 kW, mains current ≤ 16 A		No additional measures	
Mains current > 16 A ... ≤ 75 A	EN IEC 61000-3-12	With mains choke or mains filter	When designed for rated power.
Noise emission			
Category C2	EN IEC 61800-3		see rated data
Category C3			
Noise immunity			
	EN IEC 61800-3	Requirements fulfilled	

## Motor connection

Requirements for the shielded motor cable			
Capacitance per unit length		< 150/300 pF/m	≥ 4 mm <sup>2</sup> / AWG 12
		< 75/150 pF/m	≤ 2.5 mm <sup>2</sup> / AWG 14
Electric strength		U <sub>o</sub> /U = 0.6/1.0 kV	U = r.m.s. value from external conductor to external conductor U <sub>o</sub> = r.m.s. value external conductor to PE
		UL	U ≥ 600 V U = r.m.s. value from external conductor to external conductor

## Environmental conditions

Energy efficiency			
High Efficiency	EN IEC 61800-9-2	Class IE2	
Climate			
Storage	EN 60721-3-1:1997	1K3 (-25 ... +60 °C)	
Transport	EN 60721-3-2:1997	2K3 (-25 ... +70 °C)	
Operation	EN 60721-3-3:1995 + A2:1997	3K3 (-10 ... +60 °C)	Operation at a switching frequency of 2 or 4 kHz: Above +45°C: reduce rated output current by 2.5 %/°C Operation at a switching frequency of 8 or 16 kHz: Above +40°C: reduce rated output current by 2.5 %/°C relative humidity <95%, condensation not permissible
		3C3	For chemically active substances
		3S2	For mechanically active substances
Site altitude			
0 ... 1000 m amsl			Without current derating
1000 ... 4000 m amsl			Reduce rated output current by 5 %/1000 m
Pollution			
	EN IEC 61800-5-1 UL 61800-5-1	Degree of pollution 2	
Vibration resistance			
Transport	EN 60721-3-2:1997	2M2 (sine, shock)	In original packaging
Operation	DNV-CG-0339	Amplitude 1 mm	5 ... 13.2 Hz
		Acceleration resistant up to 0.7 g	13.2 ... 100 Hz
	EN IEC 61800-5-1	Amplitude 0.075 mm	10 ... 57 Hz
		Acceleration resistant up to 1 g	57 ... 150 Hz



---

### Electrical supply conditions

Power systems			
IT			Apply the measures described for IT systems!
TN			Voltage to earth: max. 300 V
TT			

The connection to different supply forms enables a worldwide application of the inverters.

The following is supported:

- 1-phase mains connection 230/240 V 60
- 3-phase mains connection 230/240 V 70
- 3-phase mains connection 230/240 V "Light Duty" 76
- 3-phase mains connection 400 V 79
- 3-phase mains connection 400 V "Light Duty" 89
- 3-phase mains connection 480 V 95
- 3-phase mains connection 480 V "Light Duty" 104

## Technical data

1-phase mains connection 230/240 V  
Rated data



---

### 1-phase mains connection 230/240 V



When selecting the inverters, please note:

The inverters i510-Cxxx/230-1 have an integrated RFI filter in the AC mains supply.

The inverters i510-Cxxx/230-2 **do not have** an integrated RFI filter in the AC mains supply.

In order to meet the EMC requirements according to EN IEC 61800-3, an external EMC filter according to IEC EN 60939 must be used.

The user must verify that the conformity with EN IEC 61800-3 is fulfilled.

---

### Rated data

The output currents apply to these operating conditions:

- At a switching frequency of 2 kHz or 4 kHz: Max. ambient temperature 45 °C.
- At a switching frequency of 8 kHz or 16 kHz: Max. ambient temperature 40 °C.



# Technical data

1-phase mains connection 230/240 V  
Rated data

Inverter			i510-C0.25/230-1	i510-C0.25/230-2	i510-C0.37/230-1	i510-C0.37/230-2
Rated power	$P_{\text{rated}}$	kW	0.25		0.37	
Rated power	$P_{\text{rated}}$	hp	0.33		0.5	
Mains voltage range			1/PE AC 170 V ... 264 V, 45 Hz ... 65 Hz			
Output voltage			3 AC 0 - 230/240 V			
Rated mains current						
without mains choke		A	4		5.7	
with mains choke		A	3.6		4.8	
Apparent output power		kVA	0.6		0.9	
Rated output current						
2 kHz		A	-			
4 kHz		A	1.7		2.4	
8 kHz		A	1.7		2.4	
16 kHz		A	1.1		1.6	
Power loss						
2 kHz		W	-			
4 kHz		W	15		18	
8 kHz		W	15		20	
16 kHz		W	19		24	
Overcurrent cycle 180 s						
Max. output current ( $\leq 8$ kHz)		A	2.6	2.6	3.6	3.6
Overload time	$T_1$	s	60	60	60	60
Recovery time	$T_2$	s	120	120	120	120
Max. output current during the recovery time		A	1.3	1.3	1.8	1.8
Overcurrent cycle 15 s						
Max. output current ( $\leq 8$ kHz)		A	3.4	3.4	4.8	4.8
Overload time	$T_1$	s	3	3	3	3
Recovery time	$T_2$	s	12	12	12	12
Max. output current during the recovery time		A	1.3	1.3	1.8	1.8
Cyclic mains switching			3 times per minute			
Brake chopper						
Max. output current			-			
Min. Brake resistor			-			
Max. shielded motor cable length						
without EMC category		m	50			
Category C1 ( $\leq 8$ kHz)		m	-			
Category C2 ( $\leq 8$ kHz)		m	15	-	15	-
Category C3 ( $\leq 8$ kHz)		m	15	-	15	-
Max. Unshielded motor cable length						
without EMC category		m	-			

# Technical data

1-phase mains connection 230/240 V

Rated data



Inverter			i510-C0.55/230-1	i510-C0.55/230-2	i510-C0.75/230-1	i510-C0.75/230-2
Rated power	$P_{rated}$	kW	0.55		0.75	
Rated power	$P_{rated}$	hp	0.75		1	
Mains voltage range			1/PE AC 170 V ... 264 V, 45 Hz ... 65 Hz			
Output voltage			3 AC 0 - 230/240 V			
Rated mains current						
without mains choke		A	7.6		10	
with mains choke		A	7.1		8.8	
Apparent output power		kVA	1.2		1.6	
Rated output current						
2 kHz		A	3.2		4.2	
4 kHz		A	3.2		4.2	
8 kHz		A	3.2		4.2	
16 kHz		A	2.1		2.8	
Power loss						
2 kHz		W	22		27	
4 kHz		W	23		29	
8 kHz		W	25		33	
16 kHz		W	30		38	
Overcurrent cycle 180 s						
Max. output current ( $\leq 8$ kHz)		A	4.8	4.8	6.3	6.3
Overload time	$T_1$	s	60	60	60	60
Recovery time	$T_2$	s	120	120	120	120
Max. output current during the recovery time		A	2.4	2.4	3.2	3.2
Overcurrent cycle 15 s						
Max. output current ( $\leq 8$ kHz)		A	6.4	6.4	8.4	8.4
Overload time	$T_1$	s	3	3	3	3
Recovery time	$T_2$	s	12	12	12	12
Max. output current during the recovery time		A	2.4	2.4	3.2	3.2
Cyclic mains switching			3 times per minute			
Brake chopper						
Max. output current			-			
Min. Brake resistor			-			
Max. shielded motor cable length						
without EMC category		m	50			
Category C1 ( $\leq 8$ kHz)		m	-			
Category C2 ( $\leq 8$ kHz)		m	20	-	20	-
Category C3 ( $\leq 8$ kHz)		m	50	-	50	-
Max. Unshielded motor cable length						
without EMC category		m	-			



# Technical data

1-phase mains connection 230/240 V  
Rated data

Inverter			i510-C1.1/230-1	i510-C1.1/230-2	i510-C1.5/230-1	i510-C1.5/230-2
<b>Rated power</b>	$P_{\text{rated}}$	<b>kW</b>	<b>1.1</b>		<b>1.5</b>	
<b>Rated power</b>	$P_{\text{rated}}$	<b>hp</b>	<b>1.5</b>		<b>2</b>	
Mains voltage range			1/PE AC 170 V ... 264 V, 45 Hz ... 65 Hz			
Output voltage			3 AC 0 - 230/240 V			
Rated mains current						
without mains choke		A	14.3		16.7	
with mains choke		A	11.9		13.9	
Apparent output power		kVA	2.2		2.6	
Rated output current						
2 kHz		A	6		7	
4 kHz		A	6		7	
8 kHz		A	6		7	
16 kHz		A	4		4.7	
Power loss						
2 kHz		W	36		41	
4 kHz		W	37		43	
8 kHz		W	42		50	
16 kHz		W	51		59	
Overcurrent cycle 180 s						
Max. output current ( $\leq 8$ kHz)		A	9	9	10.5	10.5
Overload time	$T_1$	s	60	60	60	60
Recovery time	$T_2$	s	120	120	120	120
Max. output current during the recovery time		A	4.5	4.5	5.3	5.3
Overcurrent cycle 15 s						
Max. output current ( $\leq 8$ kHz)		A	12	12	14	14
Overload time	$T_1$	s	3	3	3	3
Recovery time	$T_2$	s	12	12	12	12
Max. output current during the recovery time		A	4.5	4.5	5.3	5.3
Cyclic mains switching			3 times per minute			
Brake chopper						
Max. output current			-			
Min. Brake resistor			-			
Max. shielded motor cable length						
without EMC category		m	50			
Category C1 ( $\leq 8$ kHz)		m	-			
Category C2 ( $\leq 8$ kHz)		m	20	-	20	-
Category C3 ( $\leq 8$ kHz)		m	35	-	35	-
Max. Unshielded motor cable length						
without EMC category		m	-			

# Technical data

1-phase mains connection 230/240 V

Rated data



Inverter			i510-C2.2/230-1	i510-C2.2/230-2
Rated power	$P_{rated}$	kW	2.2	
Rated power	$P_{rated}$	hp	3	
Mains voltage range			1/PE AC 170 V ... 264 V, 45 Hz ... 65 Hz	
Output voltage			3 AC 0 - 230/240 V	
Rated mains current				
without mains choke		A	22.5	
with mains choke		A	16.9	
Apparent output power		kVA	3.6	
Rated output current				
2 kHz		A	9.6	
4 kHz		A	9.6	
8 kHz		A	9.6	
16 kHz		A	6.4	
Power loss				
2 kHz		W	54	
4 kHz		W	60	
8 kHz		W	70	
16 kHz		W	78	
Overcurrent cycle 180 s				
Max. output current ( $\leq 8$ kHz)		A	14.4	14.4
Overload time	$T_1$	s	60	60
Recovery time	$T_2$	s	120	120
Max. output current during the recovery time		A	7.2	7.2
Overcurrent cycle 15 s				
Max. output current ( $\leq 8$ kHz)		A	19.2	19.2
Overload time	$T_1$	s	3	3
Recovery time	$T_2$	s	12	12
Max. output current during the recovery time		A	7.2	7.2
Cyclic mains switching			3 times per minute	
Brake chopper				
Max. output current			-	
Min. Brake resistor			-	
Max. shielded motor cable length				
without EMC category		m	50	
Category C1 ( $\leq 8$ kHz)		m	-	
Category C2 ( $\leq 8$ kHz)		m	20	-
Category C3 ( $\leq 8$ kHz)		m	35	-
Max. Unshielded motor cable length				
without EMC category		m	-	





**Fusing data (EN 60204-1)**



A residual current device (RCD) is optional.

Fusing data for UL/NEC compliant installations: [► Fusing data](#) 44



The RCD type "F" is only permitted in 1-phase operation (L/N)!

Inverter	Fuse			Circuit breaker			RCD	
	Max. SCCR	Characteristic	Max. rated current	Max. SCCR	Characteristic	Max. rated current		Type
	kA		A	kA		A	mA	
i510-C0.25/230-1	65	gG/gL, gRL	16	65	B, C	16	≥ 30	Typ B
i510-C0.25/230-1	65	gG/gL, gRL	16	65	B, C	16	≥ 30	Typ F
i510-C0.25/230-2	65	gG/gL, gRL	16	65	B, C	16	≥ 30	Typ B
i510-C0.25/230-2	65	gG/gL, gRL	16	65	B, C	16	≥ 30	Typ F
i510-C0.37/230-1	65	gG/gL, gRL	16	65	B, C	16	≥ 30	Typ B
i510-C0.37/230-1	65	gG/gL, gRL	16	65	B, C	16	≥ 30	Typ F
i510-C0.37/230-2	65	gG/gL, gRL	16	65	B, C	16	≥ 30	Typ B
i510-C0.37/230-2	65	gG/gL, gRL	16	65	B, C	16	≥ 30	Typ F
i510-C0.55/230-1	65	gG/gL, gRL	16	65	B, C	16	≥ 30	Typ B
i510-C0.55/230-1	65	gG/gL, gRL	16	65	B, C	16	≥ 30	Typ F
i510-C0.55/230-2	65	gG/gL, gRL	16	65	B, C	16	≥ 30	Typ B
i510-C0.55/230-2	65	gG/gL, gRL	16	65	B, C	16	≥ 30	Typ F
i510-C0.75/230-1	65	gG/gL, gRL	16	65	B, C	16	≥ 30	Typ B
i510-C0.75/230-1	65	gG/gL, gRL	16	65	B, C	16	≥ 30	Typ F
i510-C0.75/230-2	65	gG/gL, gRL	16	65	B, C	16	≥ 30	Typ B
i510-C0.75/230-2	65	gG/gL, gRL	16	65	B, C	16	≥ 30	Typ F
i510-C1.1/230-1	65	gG/gL, gRL	32	65	B, C	32	≥ 30	Typ B
i510-C1.1/230-1	65	gG/gL, gRL	32	65	B, C	32	≥ 30	Typ F
i510-C1.1/230-2	65	gG/gL, gRL	32	65	B, C	32	≥ 30	Typ B
i510-C1.1/230-2	65	gG/gL, gRL	32	65	B, C	32	≥ 30	Typ F
i510-C1.5/230-1	65	gG/gL, gRL	32	65	B, C	32	≥ 30	Typ B
i510-C1.5/230-1	65	gG/gL, gRL	32	65	B, C	32	≥ 30	Typ F
i510-C1.5/230-2	65	gG/gL, gRL	32	65	B, C	32	≥ 30	Typ B
i510-C1.5/230-2	65	gG/gL, gRL	32	65	B, C	32	≥ 30	Typ F
i510-C2.2/230-1	65	gG/gL, gRL	32	65	B, C	32	≥ 30	Typ B
i510-C2.2/230-1	65	gG/gL, gRL	32	65	B, C	32	≥ 30	Typ F
i510-C2.2/230-2	65	gG/gL, gRL	32	65	B, C	32	≥ 30	Typ B
i510-C2.2/230-2	65	gG/gL, gRL	32	65	B, C	32	≥ 30	Typ F

# Technical data

1-phase mains connection 230/240 V  
Connection data



## Connection data

Rated power	P <sub>rated</sub>	kW	0.25 ... 0.75	1.1 ... 2.2
Connection description			<b>Mains connection</b>	
Connection			<b>X100</b>	
Connection type			Pluggable	
Max. Cable cross-section		mm <sup>2</sup>	2.5	6
Max. Cable cross-section		AWG	12	10
Stripping length		mm	8	8
Stripping length		in	0.3	0.3
Tightening torque		Nm	0.5	0.7
Tightening torque		lb-in	4.4	6.2
Required tool			Screwdriver 0.5 x 3.0	Screwdriver 0.6 x 3.5

Rated power	P <sub>rated</sub>	kW	0.25 ... 2.2	
Connection description			<b>PE connection</b>	
Terminal type			<b>Schraube</b>	
Max. Cable cross-section		mm <sup>2</sup>	6	
Max. Cable cross-section		AWG	10	
Stripping length		mm	10	
Stripping length		in	0.4	
Tightening torque		Nm	2	
Tightening torque		lb-in	18	
Required tool			Torx key 20	

Rated power	P <sub>rated</sub>	kW	0.25 ... 2.2	
Connection description			<b>Motor connection</b>	
Connection			<b>X105</b>	
Connection type			Pluggable	
Max. Cable cross-section		mm <sup>2</sup>	2.5	
Max. Cable cross-section		AWG	12	
Stripping length		mm	8	
Stripping length		in	0.3	
Tightening torque		Nm	0.5	
Tightening torque		lb-in	4.4	
Required tool			Screwdriver 0.5 x 3.0	

The connection data for the terminal X3 can be found under: [▶ Control connections 55](#)



## RFI filters / Mains filters

Basic information on RFI filters, mains filters and EMC: from [138](#)



EMC filters can be used both in the side structure and in the substructure.

### Maximum motor cable lengths with residual current device (RCD)

Mains connection			1-phase, 230 V		
Inverter			i510-C0.25/230-1 i510-C0.37/230-1	i510-C0.55/230-1 i510-C0.75/230-1	i510-C1.1/230-1 i510-C1.5/230-1 i510-C2.2/230-1
With integrated RFI filter					
Without EMC category Thermal limitation	Shielded motor cable length	m	50	50	50
	Unshielded motor cable length	m	100	100	200
With integrated RFI filter					
Category C1	Shielded motor cable length	m	-	-	-
Category C2		m	15	20	20
	Earth-leakage circuit breaker	mA	30	30	30
RFI filter Low Leakage					
Category C1	Shielded motor cable length	m	5	5	5
	Earth-leakage circuit breaker	mA	10	10	10
RFI filter Short Distance					
Category C1	Shielded motor cable length	m	25	25	25
Category C2		m	50	50	50
	Earth-leakage circuit breaker	mA	30	30	30
RFI filter Long Distance					
Category C1	Shielded motor cable length	m	50	50	50
Category C2		m	50	50	50
	Earth-leakage circuit breaker	mA	300	300	300

# Technical data

1-phase mains connection 230/240 V  
RFI filters / Mains filters



## Low Leakage

Inverter	Order code	Filter			Max. shielded motor cable length					
		Rated current	Dimensions (H x W x D)	Weight	C1		C2		C3	
		A	mm	kg	m	kHz				
i510-C0.25/230-1	I0FAE137B100L0000S	6	226 x 60 x 50	0.85	5	4	-	-	-	-
i510-C0.25/230-1	I0FAE137B100L0000S	6	226 x 60 x 50	0.85	5	8	-	-	-	-
i510-C0.25/230-1	I0FAE137B100L0000S	6	226 x 60 x 50	0.85	5	16	-	-	-	-
i510-C0.37/230-1	I0FAE137B100L0000S	6	226 x 60 x 50	0.85	5	4	-	-	-	-
i510-C0.37/230-1	I0FAE137B100L0000S	6	226 x 60 x 50	0.85	5	8	-	-	-	-
i510-C0.37/230-1	I0FAE137B100L0000S	6	226 x 60 x 50	0.85	5	16	-	-	-	-
i510-C0.55/230-1	I0FAE175B100L0000S	10	276 x 60 x 50	1	5	2	-	-	-	-
i510-C0.55/230-1	I0FAE175B100L0000S	10	276 x 60 x 50	1	5	4	-	-	-	-
i510-C0.55/230-1	I0FAE175B100L0000S	10	276 x 60 x 50	1	5	8	-	-	-	-
i510-C0.55/230-1	I0FAE175B100L0000S	10	276 x 60 x 50	1	5	16	-	-	-	-
i510-C0.75/230-1	I0FAE175B100L0000S	10	276 x 60 x 50	1	5	2	-	-	-	-
i510-C0.75/230-1	I0FAE175B100L0000S	10	276 x 60 x 50	1	5	4	-	-	-	-
i510-C0.75/230-1	I0FAE175B100L0000S	10	276 x 60 x 50	1	5	8	-	-	-	-
i510-C0.75/230-1	I0FAE175B100L0000S	10	276 x 60 x 50	1	5	16	-	-	-	-
i510-C1.1/230-1	I0FAE222B100L0000S	22.5	346 x 60 x 50	1.35	5	2	-	-	-	-
i510-C1.1/230-1	I0FAE222B100L0000S	22.5	346 x 60 x 50	1.35	5	4	-	-	-	-
i510-C1.1/230-1	I0FAE222B100L0000S	22.5	346 x 60 x 50	1.35	5	8	-	-	-	-
i510-C1.1/230-1	I0FAE222B100L0000S	22.5	346 x 60 x 50	1.35	5	16	-	-	-	-
i510-C1.5/230-1	I0FAE222B100L0000S	22.5	346 x 60 x 50	1.35	5	2	-	-	-	-
i510-C1.5/230-1	I0FAE222B100L0000S	22.5	346 x 60 x 50	1.35	5	4	-	-	-	-
i510-C1.5/230-1	I0FAE222B100L0000S	22.5	346 x 60 x 50	1.35	5	8	-	-	-	-
i510-C1.5/230-1	I0FAE222B100L0000S	22.5	346 x 60 x 50	1.35	5	16	-	-	-	-
i510-C2.2/230-1	I0FAE222B100L0000S	22.5	346 x 60 x 50	1.35	5	2	-	-	-	-
i510-C2.2/230-1	I0FAE222B100L0000S	22.5	346 x 60 x 50	1.35	5	4	-	-	-	-
i510-C2.2/230-1	I0FAE222B100L0000S	22.5	346 x 60 x 50	1.35	5	8	-	-	-	-
i510-C2.2/230-1	I0FAE222B100L0000S	22.5	346 x 60 x 50	1.35	5	16	-	-	-	-



In order to meet the EMC requirements according to EN IEC 61800-3, the screws marked "IT" on the product must be removed when using the filters listed below.

**Filters:** I0FAE137B100L0000S

I0FAE175B100L0000S  
I0FAE222B100L0000S

**Inverters:** I51AE125x, I51AE137x

I51AE155x, I51AE175x,  
I51AE211x, I51AE215x,  
I51AE222x

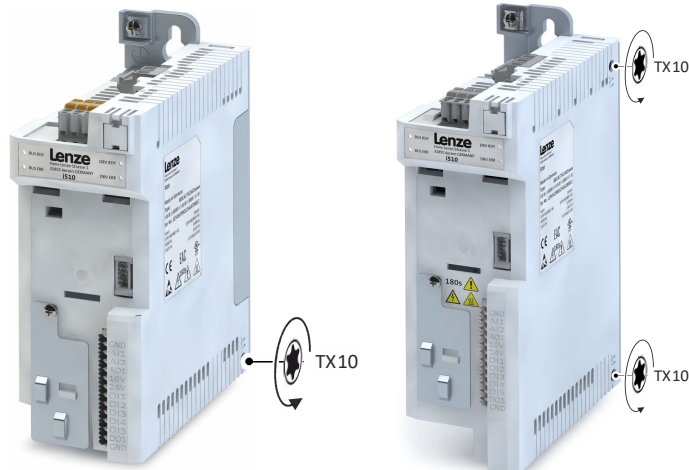



# Technical data

1-phase mains connection 230/240 V  
RFI filters / Mains filters

## Short distance filter

Inverter	Filter				Max. shielded motor cable length					
	Order code	Rated current	Dimensions (H x W x D)	Weight	C1		C2		C3	
					m	kHz	m	kHz		
i510-C0.25/230-1	I0FAE175B100S0000S	10	276 x 60 x 50	0.77	25	4	50	4	-	-
i510-C0.25/230-1	I0FAE175B100S0000S	10	276 x 60 x 50	0.77	25	8	50	8	-	-
i510-C0.25/230-1	I0FAE175B100S0000S	10	276 x 60 x 50	0.77	25	16	50	16	-	-
i510-C0.37/230-1	I0FAE175B100S0000S	10	276 x 60 x 50	0.77	25	4	50	4	-	-
i510-C0.37/230-1	I0FAE175B100S0000S	10	276 x 60 x 50	0.77	25	8	50	8	-	-
i510-C0.37/230-1	I0FAE175B100S0000S	10	276 x 60 x 50	0.77	25	16	50	16	-	-
i510-C0.55/230-1	I0FAE175B100S0000S	10	276 x 60 x 50	0.77	25	2	50	2	-	-
i510-C0.55/230-1	I0FAE175B100S0000S	10	276 x 60 x 50	0.77	25	4	50	4	-	-
i510-C0.55/230-1	I0FAE175B100S0000S	10	276 x 60 x 50	0.77	25	8	50	8	-	-
i510-C0.55/230-1	I0FAE175B100S0000S	10	276 x 60 x 50	0.77	25	16	50	16	-	-
i510-C0.75/230-1	I0FAE175B100S0000S	10	276 x 60 x 50	0.77	25	2	50	2	-	-
i510-C0.75/230-1	I0FAE175B100S0000S	10	276 x 60 x 50	0.77	25	4	50	4	-	-
i510-C0.75/230-1	I0FAE175B100S0000S	10	276 x 60 x 50	0.77	25	8	50	8	-	-
i510-C0.75/230-1	I0FAE175B100S0000S	10	276 x 60 x 50	0.77	25	16	50	16	-	-
i510-C1.1/230-1	I0FAE222B100S0000S	22.5	346 x 60 x 50	1.02	25	2	50	2	-	-
i510-C1.1/230-1	I0FAE222B100S0000S	22.5	346 x 60 x 50	1.02	25	4	50	4	-	-
i510-C1.1/230-1	I0FAE222B100S0000S	22.5	346 x 60 x 50	1.02	25	8	50	8	-	-
i510-C1.1/230-1	I0FAE222B100S0000S	22.5	346 x 60 x 50	1.02	25	16	50	16	-	-
i510-C1.5/230-1	I0FAE222B100S0000S	22.5	346 x 60 x 50	1.02	25	2	50	2	-	-
i510-C1.5/230-1	I0FAE222B100S0000S	22.5	346 x 60 x 50	1.02	25	4	50	4	-	-
i510-C1.5/230-1	I0FAE222B100S0000S	22.5	346 x 60 x 50	1.02	25	8	50	8	-	-
i510-C1.5/230-1	I0FAE222B100S0000S	22.5	346 x 60 x 50	1.02	25	16	50	16	-	-
i510-C2.2/230-1	I0FAE222B100S0000S	22.5	346 x 60 x 50	1.02	25	2	50	2	-	-
i510-C2.2/230-1	I0FAE222B100S0000S	22.5	346 x 60 x 50	1.02	25	4	50	4	-	-
i510-C2.2/230-1	I0FAE222B100S0000S	22.5	346 x 60 x 50	1.02	25	8	50	8	-	-
i510-C2.2/230-1	I0FAE222B100S0000S	22.5	346 x 60 x 50	1.02	25	16	50	16	-	-

## Long distance filter

Inverter	Filter				Max. shielded motor cable length					
	Order code	Rated current	Dimensions (H x W x D)	Weight	C1		C2		C3	
					m	kHz	m	kHz		
i510-C0.25/230-1	I0FAE175B100D0000S	10	276 x 60 x 50	0.82	50	4	50	4	-	-
i510-C0.25/230-1	I0FAE175B100D0000S	10	276 x 60 x 50	0.82	50	8	50	8	-	-
i510-C0.37/230-1	I0FAE175B100D0000S	10	276 x 60 x 50	0.82	50	4	50	4	-	-
i510-C0.37/230-1	I0FAE175B100D0000S	10	276 x 60 x 50	0.82	50	8	50	8	-	-
i510-C0.55/230-1	I0FAE175B100D0000S	10	276 x 60 x 50	0.82	50	4	50	4	-	-
i510-C0.55/230-1	I0FAE175B100D0000S	10	276 x 60 x 50	0.82	50	8	50	8	-	-
i510-C0.75/230-1	I0FAE175B100D0000S	10	276 x 60 x 50	0.82	50	4	50	4	-	-
i510-C0.75/230-1	I0FAE175B100D0000S	10	276 x 60 x 50	0.82	50	8	50	8	-	-
i510-C1.1/230-1	I0FAE222B100D0000S	22.5	346 x 60 x 50	1.09	50	4	50	4	-	-
i510-C1.1/230-1	I0FAE222B100D0000S	22.5	346 x 60 x 50	1.09	50	8	50	8	-	-
i510-C1.5/230-1	I0FAE222B100D0000S	22.5	346 x 60 x 50	1.09	50	4	50	4	-	-
i510-C1.5/230-1	I0FAE222B100D0000S	22.5	346 x 60 x 50	1.09	50	8	50	8	-	-
i510-C2.2/230-1	I0FAE222B100D0000S	22.5	346 x 60 x 50	1.09	50	4	50	4	-	-
i510-C2.2/230-1	I0FAE222B100D0000S	22.5	346 x 60 x 50	1.09	50	8	50	8	-	-



## Technical data

3-phase mains connection 230/240 V  
Rated data

---

### 3-phase mains connection 230/240 V



The inverters i510-Cxxx/230-3 and i510-Cxxx/230-2 do not have an integrated RFI filter in the AC mains supply.

In order to meet the EMC requirements according to EN IEC 61800-3, an external EMC filter according to IEC EN 60939 must be used.

The user must verify that the conformity with EN IEC 61800-3 is fulfilled.

---

#### Rated data

The output currents apply to these operating conditions:

- At a switching frequency of 2 kHz or 4 kHz: Max. ambient temperature 45 °C.
- At a switching frequency of 8 kHz or 16 kHz: Max. ambient temperature 40 °C.



# Technical data

3-phase mains connection 230/240 V  
Rated data

Inverter			i510-C0.25/230-2	i510-C0.37/230-2	i510-C0.55/230-2	i510-C0.75/230-2
<b>Rated power</b>	$P_{rated}$	<b>kW</b>	<b>0.25</b>	<b>0.37</b>	<b>0.55</b>	<b>0.75</b>
<b>Rated power</b>	$P_{rated}$	<b>hp</b>	<b>0.33</b>	<b>0.5</b>	<b>0.75</b>	<b>1</b>
Mains voltage range			3/PE AC 195 V ... 264 V, 45 Hz ... 65 Hz			
Output voltage			3 AC 0 - 230/240 V			
Rated mains current						
without mains choke		A	2.6	3.9	4.8	6.4
with mains choke		A	2	3	3.8	5.1
Apparent output power		kVA	0.6	0.9	1.2	1.6
Rated output current						
2 kHz		A	-		3.2	4.2
4 kHz		A	1.7	2.4	3.2	4.2
8 kHz		A	1.7	2.4	3.2	4.2
16 kHz		A	1.1	1.6	2.1	2.8
Power loss						
2 kHz		W	-		22	27
4 kHz		W	15	18	23	29
8 kHz		W	15	20	25	33
16 kHz		W	19	24	30	38
Overcurrent cycle 180 s						
Max. output current ( $\leq 8$ kHz)		A	2.6	3.6	4.8	6.3
Overload time	$T_1$	s	60	60	60	60
Recovery time	$T_2$	s	120	120	120	120
Max. output current during the recovery time		A	1.3	1.8	2.4	3.2
Overcurrent cycle 15 s						
Max. output current ( $\leq 8$ kHz)		A	3.4	4.8	6.4	8.4
Overload time	$T_1$	s	3	3	3	3
Recovery time	$T_2$	s	12	12	12	12
Max. output current during the recovery time		A	1.3	1.8	2.4	3.2
Cyclic mains switching			3 times per minute			
Brake chopper						
Max. output current			-			
Min. Brake resistor			-			
Max. shielded motor cable length						
without EMC category		m	50			
Category C1 ( $\leq 8$ kHz)		m	-			
Category C2 ( $\leq 8$ kHz)		m	-			
Category C3 ( $\leq 8$ kHz)		m	-			
Max. Unshielded motor cable length						
without EMC category		m	-			

# Technical data

3-phase mains connection 230/240 V

Rated data



Inverter			i510-C1.1/230-2	i510-C1.5/230-2	i510-C2.2/230-2	i510-C4.0/230-3
Rated power	P <sub>rated</sub>	kW	1.1	1.5	2.2	4
Rated power	P <sub>rated</sub>	hp	1.5	2	3	5
Mains voltage range			3/PE AC 195 V ... 264 V, 45 Hz ... 65 Hz			
Output voltage			3 AC 0 - 230/240 V			
Rated mains current						
without mains choke		A	7.8	9.5	13.6	20.6
with mains choke		A	5.6	6.8	9.8	15.7
Apparent output power		kVA	2.2	2.6	3.6	6.4
Rated output current						
2 kHz		A	6	7	9.6	16.5
4 kHz		A	6	7	9.6	16.5
8 kHz		A	6	7	9.6	16.5
16 kHz		A	4	4.7	6.4	11
Power loss						
2 kHz		W	36	41	54	113
4 kHz		W	37	43	60	115
8 kHz		W	42	50	70	130
16 kHz		W	51	59	78	116
Overcurrent cycle 180 s						
Max. output current (≤ 8 kHz)		A	9	10.5	14.4	24.8
Overload time	T <sub>1</sub>	s	60	60	60	60
Recovery time	T <sub>2</sub>	s	120	120	120	120
Max. output current during the recovery time		A	4.5	5.3	7.2	12.4
Overcurrent cycle 15 s						
Max. output current (≤ 8 kHz)		A	12	14	19.2	33
Overload time	T <sub>1</sub>	s	3	3	3	3
Recovery time	T <sub>2</sub>	s	12	12	12	12
Max. output current during the recovery time		A	4.5	5.3	7.2	12.4
Cyclic mains switching			3 times per minute			
Brake chopper						
Max. output current			-			
Min. Brake resistor			-			
Max. shielded motor cable length						
without EMC category		m	50			
Category C1 (≤ 8 kHz)		m	-			
Category C2 (≤ 8 kHz)		m	-			
Category C3 (≤ 8 kHz)		m	-			
Max. Unshielded motor cable length						
without EMC category		m	-			





# Technical data

3-phase mains connection 230/240 V  
Rated data

Inverter			i510-C5.5/230-3
Rated power	$P_{rated}$	kW	5.5
Rated power	$P_{rated}$	hp	7.5
Mains voltage range			3/PE AC 195 V ... 264 V, 45 Hz ... 65 Hz
Output voltage			3 AC 0 - 230/240 V
Rated mains current			
without mains choke		A	28.8
with mains choke		A	21.9
Apparent output power		kVA	8.7
Rated output current			
2 kHz		A	23
4 kHz		A	23
8 kHz		A	23
16 kHz		A	15.3
Power loss			
2 kHz		W	166
4 kHz		W	175
8 kHz		W	195
16 kHz		W	159
Overcurrent cycle 180 s			
Max. output current ( $\leq 8$ kHz)		A	34.5
Overload time	$T_1$	s	60
Recovery time	$T_2$	s	120
Max. output current during the recovery time		A	17.3
Overcurrent cycle 15 s			
Max. output current ( $\leq 8$ kHz)		A	46
Overload time	$T_1$	s	3
Recovery time	$T_2$	s	12
Max. output current during the recovery time		A	17.3
Cyclic mains switching			3 times per minute
Brake chopper			
Max. output current			-
Min. Brake resistor			-
Max. shielded motor cable length			
without EMC category		m	50
Category C1 ( $\leq 8$ kHz)		m	-
Category C2 ( $\leq 8$ kHz)		m	-
Category C3 ( $\leq 8$ kHz)		m	-
Max. Unshielded motor cable length			
without EMC category		m	-

# Technical data

3-phase mains connection 230/240 V  
Fusing data (EN 60204-1)



## Fusing data (EN 60204-1)



A residual current device (RCD) is optional.

Fusing data for UL/NEC compliant installations: [► Fusing data](#)  44

Inverter	Fuse			Circuit breaker			RCD	
	Max. SCCR	Characteristic	Max. rated current	Max. SCCR	Characteristic	Max. rated current		Type
	kA		A	kA		A	mA	
i510-C0.25/230-2	65	gG/gL, gRL	16	65	B, C	16	≥ 30	Typ B
i510-C0.37/230-2	65	gG/gL, gRL	16	65	B, C	16	≥ 30	Typ B
i510-C0.55/230-2	65	gG/gL, gRL	16	65	B, C	16	≥ 30	Typ B
i510-C0.75/230-2	65	gG/gL, gRL	16	65	B, C	16	≥ 30	Typ B
i510-C1.1/230-2	65	gG/gL, gRL	32	65	B, C	32	≥ 30	Typ B
i510-C1.5/230-2	65	gG/gL, gRL	32	65	B, C	32	≥ 30	Typ B
i510-C2.2/230-2	65	gG/gL, gRL	32	65	B, C	32	≥ 30	Typ B
i510-C4.0/230-3	65	gG/gL, gRL	40	65	B, C	40	≥ 300	Typ B
i510-C5.5/230-3	65	gG/gL, gRL	40	65	B, C	40	≥ 300	Typ B



# Technical data

3-phase mains connection 230/240 V  
Connection data

## Connection data

Rated power	P <sub>rated</sub>	kW	0.25 ... 0.75	1.1 ... 2.2	4 ... 5.5
<b>Connection description</b>			<b>Mains connection</b>		
<b>Connection</b>			<b>X100</b>		
Connection type			Pluggable		Non-pluggable
Max. Cable cross-section		mm <sup>2</sup>	2.5	6	6
Max. Cable cross-section		AWG	12	10	10
Stripping length		mm	8	8	9
Stripping length		in	0.3	0.3	0.35
Tightening torque		Nm	0.5	0.7	0.5
Tightening torque		lb-in	4.4	6.2	4.4
Required tool			Screwdriver 0.5 x 3.0		Screwdriver 0.6 x 3.5

Rated power	P <sub>rated</sub>	kW	0.25 ... 5.5		
<b>Connection description</b>			<b>PE connection</b>		
<b>Terminal type</b>			<b>Schraube</b>		
Max. Cable cross-section		mm <sup>2</sup>	6		
Max. Cable cross-section		AWG	10		
Stripping length		mm	10		
Stripping length		in	0.4		
Tightening torque		Nm	2		
Tightening torque		lb-in	18		
Required tool			Torx key 20		

Rated power	P <sub>rated</sub>	kW	0.25 ... 2.2	4 ... 5.5
<b>Connection description</b>			<b>Motor connection</b>	
<b>Connection</b>			<b>X105</b>	
Connection type			Pluggable	Non-pluggable
Max. Cable cross-section		mm <sup>2</sup>	2.5	6
Max. Cable cross-section		AWG	12	10
Stripping length		mm	8	9
Stripping length		in	0.3	0.35
Tightening torque		Nm	0.5	0.5
Tightening torque		lb-in	4.4	4.4
Required tool			Screwdriver 0.5 x 3.0	Screwdriver 0.6 x 3.5

The connection data for the terminal X3 can be found under: [▶ Control connections 55](#)

## Technical data

3-phase mains connection 230/240 V "Light Duty"  
Rated data



---

### 3-phase mains connection 230/240 V "Light Duty"



The inverters i510-Cxxx/230-3 do not have an integrated RFI filter in the AC mains supply.

In order to meet the EMC requirements according to EN IEC 61800-3, an external EMC filter according to IEC EN 60939 must be used.

The user must verify that the conformity with EN IEC 61800-3 is fulfilled.

---

#### Rated data

The output currents apply to these operating conditions:

- At a switching frequency of 2 kHz or 4 kHz: Ambient temperature above 40 °C with a rated output current reduced by 2.5 %/°C.
- If the load characteristic "Light Duty" and the switching frequencies 8 kHz or 16 kHz are selected, only the values of the load characteristic "Heavy Duty" are reached.



# Technical data

3-phase mains connection 230/240 V "Light Duty"  
Rated data

Inverter			i510-C4.0/230-3	i510-C5.5/230-3
Rated power	P <sub>rated</sub>	kW	5.5	7.5
Rated power	P <sub>rated</sub>	hp	7.5	10
Mains voltage range			3/PE AC 195 V ... 264 V, 45 Hz ... 65 Hz	
Output voltage			3 AC 0 - 230/240 V	
Rated mains current				
without mains choke		A	25.8	-
with mains choke		A	18.9	24.2
Apparent output power		kVA	8	10.5
Rated output current				
2 kHz		A	20.6	27.6
4 kHz		A	20.6	27.6
8 kHz		A	-	-
16 kHz		A	-	-
Power loss				
2 kHz		W	124	190
4 kHz		W	131	200
8 kHz		W	-	-
16 kHz		W	-	-
Overcurrent cycle 180 s				
Max. output current (≤ 8 kHz)		A	24.8	34.5
Overload time	T <sub>1</sub>	s	60	60
Recovery time	T <sub>2</sub>	s	120	120
Max. output current during the recovery time		A	12.4	17.3
Overcurrent cycle 15 s				
Max. output current (≤ 8 kHz)		A	33	46
Overload time	T <sub>1</sub>	s	3	3
Recovery time	T <sub>2</sub>	s	12	12
Max. output current during the recovery time		A	12.4	17.3
Cyclic mains switching			3 times per minute	
Brake chopper				
Max. output current			-	
Min. Brake resistor			-	
Max. shielded motor cable length				
without EMC category		m	50	
Category C1 (≤ 8 kHz)		m	-	
Category C2 (≤ 8 kHz)		m	-	
Category C3 (≤ 8 kHz)		m	-	
Max. Unshielded motor cable length				
without EMC category		m	-	

# Technical data

3-phase mains connection 230/240 V "Light Duty"  
Fusing data (EN 60204-1)



## Fusing data (EN 60204-1)



A residual current device (RCD) is optional.

Fusing data for UL/NEC compliant installations: [▶ Fusing data](#) 44

Inverter	Fuse			Circuit breaker			RCD	
	Max. SCCR	Characteristic	Max. rated current	Max. SCCR	Characteristic	Max. rated current		Type
	kA		A	kA		A	mA	
i510-C4.0/230-3	65	gG/gL, gRL	40	65	B, C	40	≥ 300	Typ B
i510-C5.5/230-3	65	gG/gL, gRL	40	65	B, C	40	≥ 300	Typ B

## Connection data

See "3-phase mains connection 230/240 V" [▶ Connection data](#) 75

The connection data for the terminal X3 can be found under: [▶ Control connections](#) 55



### **3-phase mains connection 400 V**

#### **Rated data**

The output currents apply to these operating conditions:

- At a switching frequency of 2 kHz or 4 kHz: Max. ambient temperature 45 °C.
- At a switching frequency of 8 kHz or 16 kHz: Max. ambient temperature 40 °C.

# Technical data

3-phase mains connection 400 V

Rated data



Inverter			i510-C0.37/400-3	i510-C0.55/400-3	i510-C0.75/400-3	i510-C1.1/400-3
Rated power	P <sub>rated</sub>	kW	0.37	0.55	0.75	1.1
Rated power	P <sub>rated</sub>	hp	0.5	0.75	1	1.5
Mains voltage range			3/PE AC 340 V ... 528 V, 45 Hz ... 65 Hz			
Output voltage			3 AC 0 - 400/480 V			
Rated mains current						
without mains choke		A	1.8	2.5	3.3	4.4
with mains choke		A	1.4	2	2.6	3
Apparent output power		kVA	0.9	1.2	1.6	2.2
Rated output current						
2 kHz		A	-	1.8	2.4	3.2
4 kHz		A	1.3	1.8	2.4	3.2
8 kHz		A	1.3	1.8	2.4	3.2
16 kHz		A	0.9	1.2	1.6	2.1
Power loss						
2 kHz		W	-	24	30	38
4 kHz		W	20	25	32	40
8 kHz		W	24	31	40	51
16 kHz		W	24	31	40	51
Overcurrent cycle 180 s						
Max. output current (≤ 8 kHz)		A	2	2.7	3.6	4.8
Overload time	T <sub>1</sub>	s	60	60	60	60
Recovery time	T <sub>2</sub>	s	120	120	120	120
Max. output current during the recovery time		A	1	1.4	1.8	2.4
Overcurrent cycle 15 s						
Max. output current (≤ 8 kHz)		A	2.6	3.6	4.8	6.4
Overload time	T <sub>1</sub>	s	3	3	3	3
Recovery time	T <sub>2</sub>	s	12	12	12	12
Max. output current during the recovery time		A	1	1.4	1.8	2.4
Cyclic mains switching			3 times per minute			
Brake chopper						
Max. output current			-			
Min. Brake resistor			-			
Max. shielded motor cable length						
without EMC category		m	15	50		
Category C1 (≤ 8 kHz)		m	-			3
Category C2 (≤ 8 kHz)		m	15			20
Category C3 (≤ 8 kHz)		m	15	20		35
Max. Unshielded motor cable length						
without EMC category		m	-			





# Technical data

3-phase mains connection 400 V  
Rated data

Inverter			i510-C1.5/400-3	i510-C2.2/400-3	i510-C3.0/400-3	i510-C4.0/400-3
Rated power	P <sub>rated</sub>	kW	1.5	2.2	3	4
Rated power	P <sub>rated</sub>	hp	2	3	4	5
Mains voltage range			3/PE AC 340 V ... 528 V, 45 Hz ... 65 Hz			
Output voltage			3 AC 0 - 400/480 V			
Rated mains current						
without mains choke		A	5.4	7.8	9.6	12.5
with mains choke		A	3.7	5.3	6.9	9
Apparent output power		kVA	2.6	3.8	4.9	6.4
Rated output current						
2 kHz		A	3.9	5.6	7.3	9.5
4 kHz		A	3.9	5.6	7.3	9.5
8 kHz		A	3.9	5.6	7.3	9.5
16 kHz		A	2.6	3.7	4.9	6.3
Power loss						
2 kHz		W	45	62	79	102
4 kHz		W	48	66	85	110
8 kHz		W	61	85	110	140
16 kHz		W	61	85	109	140
Overcurrent cycle 180 s						
Max. output current (≤ 8 kHz)		A	5.9	8.4	11	14.3
Overload time	T <sub>1</sub>	s	60	60	60	60
Recovery time	T <sub>2</sub>	s	120	120	120	120
Max. output current during the recovery time		A	2.9	4.2	5.5	7.1
Overcurrent cycle 15 s						
Max. output current (≤ 8 kHz)		A	7.8	11.2	14.6	19
Overload time	T <sub>1</sub>	s	3	3	3	3
Recovery time	T <sub>2</sub>	s	12	12	12	12
Max. output current during the recovery time		A	2.9	4.2	5.5	7.1
Cyclic mains switching			3 times per minute			
Brake chopper						
Max. output current			-			
Min. Brake resistor			-			
Max. shielded motor cable length						
without EMC category		m	50		100	
Category C1 (≤ 8 kHz)		m	3		-	
Category C2 (≤ 8 kHz)		m	20			
Category C3 (≤ 8 kHz)		m	35			
Max. Unshielded motor cable length						
without EMC category		m	-			

# Technical data

3-phase mains connection 400 V

Rated data



Inverter			i510-C5.5/400-3	i510-C7.5/400-3	i510-C11/400-3
Rated power	P <sub>rated</sub>	kW	5.5	7.5	11
Rated power	P <sub>rated</sub>	hp	7.5	10	15
Mains voltage range			3/PE AC 340 V ... 528 V, 45 Hz ... 65 Hz		
Output voltage			3 AC 0 - 400/480 V		
Rated mains current					
without mains choke		A	17.2	20	28.4
with mains choke		A	12.4	15.7	22.3
Apparent output power		kVA	8.7	11	16
Rated output current					
2 kHz		A	13	16.5	23.5
4 kHz		A	13	16.5	23.5
8 kHz		A	13	16.5	23.5
16 kHz		A	8.7	11	15.7
Power loss					
2 kHz		W	137	172	242
4 kHz		W	145	185	260
8 kHz		W	190	240	340
16 kHz		W	189	238	337
Overcurrent cycle 180 s					
Max. output current (≤ 8 kHz)		A	19.5	25	35
Overload time	T <sub>1</sub>	s	60	60	60
Recovery time	T <sub>2</sub>	s	120	120	120
Max. output current during the recovery time		A	9.8	12.4	17.6
Overcurrent cycle 15 s					
Max. output current (≤ 8 kHz)		A	26	33	47
Overload time	T <sub>1</sub>	s	3	3	3
Recovery time	T <sub>2</sub>	s	12	12	12
Max. output current during the recovery time		A	9.8	12.4	17.6
Cyclic mains switching			3 times per minute		
Brake chopper					
Max. output current			-		
Min. Brake resistor			-		
Max. shielded motor cable length					
without EMC category		m	100		
Category C1 (≤ 8 kHz)		m	-		
Category C2 (≤ 8 kHz)		m	20		
Category C3 (≤ 8 kHz)		m	35	50	
Max. Unshielded motor cable length					
without EMC category		m	-		



**Fusing data (EN 60204-1)**



A residual current device (RCD) is optional.

Fusing data for UL/NEC compliant installations: [▶ Fusing data](#) 44

Inverter	Fuse			Circuit breaker			RCD	
	Max. SCCR	Characteristic	Max. rated current	Max. SCCR	Characteristic	Max. rated current		Type
	kA		A	kA		A	mA	
i510-C0.37/400-3	65	gG/gL, gRL	16	65	B, C	16	≥ 30	Typ B
i510-C0.55/400-3	65	gG/gL, gRL	16	65	B, C	16	≥ 30	Typ B
i510-C0.75/400-3	65	gG/gL, gRL	16	65	B, C	16	≥ 30	Typ B
i510-C1.1/400-3	65	gG/gL, gRL	16	65	B, C	16	≥ 30	Typ B
i510-C1.5/400-3	65	gG/gL, gRL	16	65	B, C	16	≥ 30	Typ B
i510-C2.2/400-3	65	gG/gL, gRL	16	65	B, C	16	≥ 30	Typ B
i510-C3.0/400-3	65	gG/gL, gRL	35	65	B, C	25	≥ 30	Typ B
i510-C4.0/400-3	65	gG/gL, gRL	35	65	B, C	25	≥ 30	Typ B
i510-C5.5/400-3	65	gG/gL, gRL	25	65	B, C	25	≥ 300	Typ B
i510-C7.5/400-3	65	gG/gL, gRL	40	65	B, C	40	≥ 30	Typ B
i510-C11/400-3	65	gG/gL, gRL	40	65	B, C	40	≥ 30	Typ B

# Technical data

3-phase mains connection 400 V  
Connection data



## Connection data

Rated power	P <sub>rated</sub>	kW	0.37 ... 2.2	3 ... 4	5.5	7.5 ... 11
Connection description			<b>Mains connection</b>			
Connection			<b>X100</b>			
Connection type			Pluggable		Non-pluggable	
Max. Cable cross-section		mm <sup>2</sup>	2.5	4	6	16
Max. Cable cross-section		AWG	12	10	10	6
Stripping length		mm	8	8	9	11
Stripping length		in	0.3	0.3	0.35	0.43
Tightening torque		Nm	0.5	0.6	0.5	1.2
Tightening torque		lb-in	4.4	5.3	4.4	11
Required tool			Screwdriver 0.5 x 3.0		Screwdriver 0.6 x 3.5	Screwdriver 0.8 x 4.0

Rated power	P <sub>rated</sub>	kW	0.37 ... 5.5	7.5 ... 11
Connection description			<b>PE connection</b>	
Terminal type			<b>Schraube</b>	
Max. Cable cross-section		mm <sup>2</sup>	6	16
Max. Cable cross-section		AWG	10	6
Stripping length		mm	10	11
Stripping length		in	0.4	0.4
Tightening torque		Nm	2	3.4
Tightening torque		lb-in	18	30
Required tool			Torx key 20	Crosstip screwdriver PZ2

Rated power	P <sub>rated</sub>	kW	0.37 ... 4	5.5	7.5 ... 11
Connection description			<b>Motor connection</b>		
Connection			<b>X105</b>		
Connection type			Pluggable	Non-pluggable	
Max. Cable cross-section		mm <sup>2</sup>	2.5	6	16
Max. Cable cross-section		AWG	12	10	6
Stripping length		mm	8	9	11
Stripping length		in	0.3	0.35	0.43
Tightening torque		Nm	0.5	0.5	1.2
Tightening torque		lb-in	4.4	4.4	11
Required tool			Screwdriver 0.5 x 3.0	Screwdriver 0.6 x 3.5	Screwdriver 0.8 x 4.0

The connection data for the terminal X3 can be found under: [▶ Control connections 55](#)



## RFI filters / Mains filters

Basic information on RFI filters, mains filters and EMC: from [138](#)



EMC filters can be used both in the side structure and in the substructure.

### Maximum motor cable lengths with residual current device (RCD)

Mains connection			3-phase, 400 V/480 V			
Inverter			i510-C0.37/400-3	i510-C0.55/400-3 i510-C0.75/400-3	i510-C1.1/400-3 i510-C1.5/400-3 i510-C2.2/400-3 i510-C3.0/400-3 i510-C4.0/400-3	i510-C5.5/400-3 i510-C7.5/400-3 i510-C11/400-3
Without RFI filter						
Without EMC category Thermal limitation	Max. motor cable length shielded	m	15	50	50	100
	Max. motor cable length unshielded	m	30	100	200	200
With integrated RFI filter						
Category C1	Max. motor cable length shielded	m	-	-	-	-
Category C2		m	15	15	20	20
		RCD (optional)	mA	30	30	30
RFI filter Low Leakage						
Category C1	Max. motor cable length shielded	m	-	-	-	-
		RCD (optional)	mA	-	-	-
RFI filter Short Distance						
Category C1	Max. motor cable length shielded	m	15	25	25	25
Category C2		m	15	50	50	50
		RCD (optional)	mA	30	30	30
RFI filter Long Distance						
Category C1	Max. motor cable length shielded	m	15	50	50	50
Category C2		m	15	50	50	100
		RCD (optional)	mA	300	300	300

# Technical data

3-phase mains connection 400 V  
RFI filters / Mains filters



## Short distance filter

Inverter	Filter				Max. shielded motor cable length					
	Order code	Rated current	Dimensions (H x W x D)	Weight	C1		C2		C3	
					m	kHz	m	kHz		
i510-C0.37/400-3	IOFAE175F100S0000S	3.3	276 x 60 x 50	0.82	15	4	15	4	-	-
i510-C0.37/400-3	IOFAE175F100S0000S	3.3	276 x 60 x 50	0.82	15	8	15	8	-	-
i510-C0.37/400-3	IOFAE175F100S0000S	3.3	276 x 60 x 50	0.82	15	16	15	16	-	-
i510-C0.55/400-3	IOFAE175F100S0000S	3.3	276 x 60 x 50	0.82	25	2	50	2	-	-
i510-C0.55/400-3	IOFAE175F100S0000S	3.3	276 x 60 x 50	0.82	25	4	50	4	-	-
i510-C0.55/400-3	IOFAE175F100S0000S	3.3	276 x 60 x 50	0.82	25	8	50	8	-	-
i510-C0.55/400-3	IOFAE175F100S0000S	3.3	276 x 60 x 50	0.82	25	16	50	16	-	-
i510-C0.75/400-3	IOFAE175F100S0000S	3.3	276 x 60 x 50	0.82	25	2	50	2	-	-
i510-C0.75/400-3	IOFAE175F100S0000S	3.3	276 x 60 x 50	0.82	25	4	50	4	-	-
i510-C0.75/400-3	IOFAE175F100S0000S	3.3	276 x 60 x 50	0.82	25	8	50	8	-	-
i510-C0.75/400-3	IOFAE175F100S0000S	3.3	276 x 60 x 50	0.82	25	16	50	16	-	-
i510-C1.1/400-3	IOFAE222F100S0000S	7.8	346 x 60 x 50	1.01	25	2	50	2	-	-
i510-C1.1/400-3	IOFAE222F100S0000S	7.8	346 x 60 x 50	1.01	25	4	50	4	-	-
i510-C1.1/400-3	IOFAE222F100S0000S	7.8	346 x 60 x 50	1.01	25	8	50	8	-	-
i510-C1.1/400-3	IOFAE222F100S0000S	7.8	346 x 60 x 50	1.01	25	16	50	16	-	-
i510-C1.5/400-3	IOFAE222F100S0000S	7.8	346 x 60 x 50	1.01	25	2	50	2	-	-
i510-C1.5/400-3	IOFAE222F100S0000S	7.8	346 x 60 x 50	1.01	25	4	50	4	-	-
i510-C1.5/400-3	IOFAE222F100S0000S	7.8	346 x 60 x 50	1.01	25	8	50	8	-	-
i510-C1.5/400-3	IOFAE222F100S0000S	7.8	346 x 60 x 50	1.01	25	16	50	16	-	-
i510-C2.2/400-3	IOFAE222F100S0000S	7.8	346 x 60 x 50	1.01	25	2	50	2	-	-
i510-C2.2/400-3	IOFAE222F100S0000S	7.8	346 x 60 x 50	1.01	25	4	50	4	-	-
i510-C2.2/400-3	IOFAE222F100S0000S	7.8	346 x 60 x 50	1.01	25	8	50	8	-	-
i510-C2.2/400-3	IOFAE222F100S0000S	7.8	346 x 60 x 50	1.01	25	16	50	16	-	-
i510-C3.0/400-3	IOFAE240F100S0001S	14	346 x 60 x 50	1.42	25	2	50	2	-	-
i510-C3.0/400-3	IOFAE240F100S0001S	14	346 x 60 x 50	1.42	25	4	50	4	-	-
i510-C3.0/400-3	IOFAE240F100S0001S	14	346 x 60 x 50	1.42	25	8	50	8	-	-
i510-C3.0/400-3	IOFAE240F100S0001S	14	346 x 60 x 50	1.42	25	16	50	16	-	-
i510-C4.0/400-3	IOFAE240F100S0001S	14	346 x 60 x 50	1.42	25	2	50	2	-	-
i510-C4.0/400-3	IOFAE240F100S0001S	14	346 x 60 x 50	1.42	25	4	50	4	-	-
i510-C4.0/400-3	IOFAE240F100S0001S	14	346 x 60 x 50	1.42	25	8	50	8	-	-
i510-C4.0/400-3	IOFAE240F100S0001S	14	346 x 60 x 50	1.42	25	16	50	16	-	-
i510-C5.5/400-3	IOFAE255F100S0001S	18.3	346 x 90 x 60	2.05	25	4	50	4	-	-
i510-C5.5/400-3	IOFAE255F100S0001S	18.3	346 x 90 x 60	2.05	25	8	50	8	-	-
i510-C7.5/400-3	IOFAE311F100S0000S	29	371 x 120 x 60	2.35	25	4	50	4	-	-
i510-C7.5/400-3	IOFAE311F100S0000S	29	371 x 120 x 60	2.35	25	8	50	8	-	-
i510-C11/400-3	IOFAE311F100S0000S	29	371 x 120 x 60	2.35	25	4	50	4	-	-
i510-C11/400-3	IOFAE311F100S0000S	29	371 x 120 x 60	2.35	25	8	50	8	-	-



In order to meet the EMC requirements according to EN IEC 61800-3, the lower of the screws marked "IT" on the product must be removed when using the filters listed below.

**Filters:** IOFAE240F100S0001S  
IOFAE255F100S0001S  
IOFAE311F100S0000S

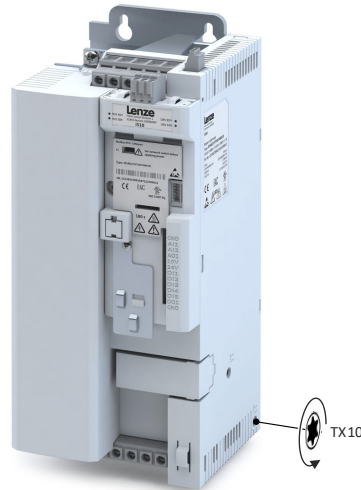

### Long distance filter

Inverter	Filter	Max. shielded motor cable length												
		Order code	Rated current A	Dimensions (H x W x D) mm	Weight kg	C1			C2			C3		
						m	kHz	m	kHz	m	kHz	m	kHz	
i510-C0.37/400-3	IOFAE175F100D0000S	3.3	276 x 60 x 50	0.86	15	4	15	4	-	-	-	-	-	-
i510-C0.37/400-3	IOFAE175F100D0000S	3.3	276 x 60 x 50	0.86	15	8	15	8	-	-	-	-	-	-
i510-C0.55/400-3	IOFAE175F100D0000S	3.3	276 x 60 x 50	0.86	50	4	50	4	-	-	-	-	-	-
i510-C0.55/400-3	IOFAE175F100D0000S	3.3	276 x 60 x 50	0.86	50	8	50	8	-	-	-	-	-	-
i510-C0.75/400-3	IOFAE175F100D0000S	3.3	276 x 60 x 50	0.86	50	4	50	4	-	-	-	-	-	-
i510-C0.75/400-3	IOFAE175F100D0000S	3.3	276 x 60 x 50	0.86	50	8	50	8	-	-	-	-	-	-
i510-C1.1/400-3	IOFAE222F100D0000S	7.8	346 x 60 x 50	1.03	50	4	50	4	-	-	-	-	-	-
i510-C1.1/400-3	IOFAE222F100D0000S	7.8	346 x 60 x 50	1.03	50	8	50	8	-	-	-	-	-	-
i510-C1.5/400-3	IOFAE222F100D0000S	7.8	346 x 60 x 50	1.03	50	4	50	4	-	-	-	-	-	-
i510-C1.5/400-3	IOFAE222F100D0000S	7.8	346 x 60 x 50	1.03	50	8	50	8	-	-	-	-	-	-
i510-C2.2/400-3	IOFAE222F100D0000S	7.8	346 x 60 x 50	1.03	50	4	50	4	-	-	-	-	-	-
i510-C2.2/400-3	IOFAE222F100D0000S	7.8	346 x 60 x 50	1.03	50	8	50	8	-	-	-	-	-	-
i510-C3.0/400-3	IOFAE240F100D0001S	14	346 x 60 x 50	1.42	50	4	50	4	-	-	-	-	-	-
i510-C3.0/400-3	IOFAE240F100D0001S	14	346 x 60 x 50	1.42	50	8	50	8	-	-	-	-	-	-
i510-C4.0/400-3	IOFAE240F100D0001S	14	346 x 60 x 50	1.42	50	4	50	4	-	-	-	-	-	-
i510-C4.0/400-3	IOFAE240F100D0001S	14	346 x 60 x 50	1.42	50	8	50	8	-	-	-	-	-	-
i510-C5.5/400-3	IOFAE255F100D0001S	18.3	346 x 90 x 60	1.65	50	4	100	4	-	-	-	-	-	-
i510-C5.5/400-3	IOFAE255F100D0001S	18.3	346 x 90 x 60	1.65	50	8	100	8	-	-	-	-	-	-
i510-C7.5/400-3	IOFAE311F100D0000S	29	371 x 120 x 60	2.05	50	4	100	4	-	-	-	-	-	-
i510-C7.5/400-3	IOFAE311F100D0000S	29	371 x 120 x 60	2.05	50	8	100	8	-	-	-	-	-	-
i510-C11/400-3	IOFAE311F100D0000S	29	371 x 120 x 60	2.05	50	4	100	4	-	-	-	-	-	-
i510-C11/400-3	IOFAE311F100D0000S	29	371 x 120 x 60	2.05	50	8	100	8	-	-	-	-	-	-

# Technical data

3-phase mains connection 400 V  
Sine filters



## Sine filters

Inverter		Sine filters		
	Switching frequency	Order code	Rated inductance	Max. output frequency
	kHz		mH	Hz
i510-C3.0/400-3	4	EZS3-010A200	5.10	150
i510-C4.0/400-3		EZS3-017A200	3.07	
i510-C5.5/400-3		EZS3-024A200	2.50	
i510-C7.5/400-3		EZS3-032A200	2.00	
i510-C11/400-3				

Inverter		Sine filters		
	Switching frequency	Order code	Rated inductance	Max. output frequency
	kHz		mH	Hz
i510-C0.37/400-3	4 8	EZS3-004A200	11.0	150
i510-C0.55/400-3				
i510-C0.75/400-3				
i510-C1.1/400-3				
i510-C1.5/400-3		EZS3-010A200	5.10	
i510-C2.2/400-3				
i510-C3.0/400-3				
i510-C4.0/400-3				
i510-C5.5/400-3		EZS3-017A200	3.07	
i510-C7.5/400-3				
i510-C11/400-3				
		EZS3-024A200	2.50	
		EZS3-032A200	2.00	





### **3-phase mains connection 400 V "Light Duty"**

#### **Rated data**

The output currents apply to these operating conditions:

- At a switching frequency of 2 kHz or 4 kHz: Ambient temperature above 40 °C with a rated output current reduced by 2.5 %/°C.
- If the load characteristic "Light Duty" and the switching frequencies 8 kHz or 16 kHz are selected, only the values of the load characteristic "Heavy Duty" are reached.

# Technical data

3-phase mains connection 400 V "Light Duty"

Rated data



Inverter			i510-C3.0/400-3	i510-C4.0/400-3	i510-C5.5/400-3	i510-C7.5/400-3
Rated power	P <sub>rated</sub>	kW	4	5.5	7.5	11
Rated power	P <sub>rated</sub>	hp	5	7.5	10	15
Mains voltage range			3/PE AC 340 V ... 528 V, 45 Hz ... 65 Hz			
Output voltage			3 AC 0 - 400/480 V			
Rated mains current						
without mains choke		A	10.3	14	18.3	28
with mains choke		A	8.2	11	14.5	22
Apparent output power		kVA	5.9	8	10.5	15
Rated output current						
2 kHz		A	8.8	11.9	15.6	23
4 kHz		A	8.8	11.9	15.6	23
8 kHz		A	-			
16 kHz		A	-			
Power loss						
2 kHz		W	94	125	163	238
4 kHz		W	100	133	173	253
8 kHz		W	-			
16 kHz		W	-			
Overcurrent cycle 180 s						
Max. output current (≤ 8 kHz)		A	11	14.3	19.5	23.6
Overload time	T <sub>1</sub>	s	60	60	60	60
Recovery time	T <sub>2</sub>	s	120	120	120	120
Max. output current during the recovery time		A	5.5	7.1	9.8	12.4
Overcurrent cycle 15 s						
Max. output current (≤ 8 kHz)		A	14.6	19	26	33
Overload time	T <sub>1</sub>	s	3	3	3	3
Recovery time	T <sub>2</sub>	s	12	12	12	12
Max. output current during the recovery time		A	5.5	7.1	9.8	12.4
Cyclic mains switching			3 times per minute			
Brake chopper						
Max. output current			-			
Min. Brake resistor			-			
Max. shielded motor cable length						
without EMC category		m	100			
Category C1 (≤ 8 kHz)		m	-			
Category C2 (≤ 8 kHz)		m	20			
Category C3 (≤ 8 kHz)		m	35			50
Max. Unshielded motor cable length						
without EMC category		m	-			



# Technical data

3-phase mains connection 400 V "Light Duty"  
Rated data

Inverter			i510-C11/400-3
Rated power	$P_{rated}$	kW	15
Rated power	$P_{rated}$	hp	20
Mains voltage range			3/PE AC 340 V ... 528 V, 45 Hz ... 65 Hz
Output voltage			3 AC 0 - 400/480 V
Rated mains current			
without mains choke		A	-
with mains choke		A	27.1
Apparent output power		kVA	19
Rated output current			
2 kHz		A	28.2
4 kHz		A	28.2
8 kHz		A	-
16 kHz		A	-
Power loss			
2 kHz		W	290
4 kHz		W	309
8 kHz		W	-
16 kHz		W	-
Overcurrent cycle 180 s			
Max. output current ( $\leq 8$ kHz)		A	35
Overload time	$T_1$	s	60
Recovery time	$T_2$	s	120
Max. output current during the recovery time		A	17.6
Overcurrent cycle 15 s			
Max. output current ( $\leq 8$ kHz)		A	47
Overload time	$T_1$	s	3
Recovery time	$T_2$	s	12
Max. output current during the recovery time		A	17.6
Cyclic mains switching			3 times per minute
Brake chopper			
Max. output current			-
Min. Brake resistor			-
Max. shielded motor cable length			
without EMC category		m	100
Category C1 ( $\leq 8$ kHz)		m	-
Category C2 ( $\leq 8$ kHz)		m	20
Category C3 ( $\leq 8$ kHz)		m	50
Max. Unshielded motor cable length			
without EMC category		m	-

# Technical data

3-phase mains connection 400 V "Light Duty"  
Fusing data (EN 60204-1)



## Fusing data (EN 60204-1)



A residual current device (RCD) is optional.

Fusing data for UL/NEC compliant installations: [▶ Fusing data](#) 44

Inverter	Fuse			Circuit breaker			RCD	
	Max. SCCR	Characteristic	Max. rated current	Max. SCCR	Characteristic	Max. rated current		Type
	kA		A	kA		A	mA	
i510-C3.0/400-3	65	gG/gL, gRL	35	65	B, C	25	≥ 30	Typ B
i510-C4.0/400-3	65	gG/gL, gRL	35	65	B, C	25	≥ 30	Typ B
i510-C5.5/400-3	65	gG/gL, gRL	25	65	B, C	25	≥ 300	Typ B
i510-C7.5/400-3	65	gG/gL, gRL	40	65	B, C	40	≥ 30	Typ B
i510-C11/400-3	65	gG/gL, gRL	40	65	B, C	40	≥ 30	Typ B

## Connection data

See "3-phase mains connection 400 V" [▶ Connection data](#) 84

The connection data for the terminal X3 can be found under: [▶ Control connections](#) 55



### RFI filters / Mains filters

Basic information on RFI filters, mains filters and EMC: from [138](#)



EMC filters can be used both in the side structure and in the substructure.

### Maximum motor cable lengths with residual current device (RCD)

Mains connection			3-phase, 400 V/480 V	
Inverter			i510-C3.0/400-3 i510-C4.0/400-3	i510-C5.5/400-3 i510-C7.5/400-3 i510-C11/400-3
Without RFI filter				
Without EMC category Thermal limitation	Max. motor cable length shielded	m	50	100
	Max. motor cable length unshielded	m	200	200
With integrated RFI filter				
Category C1	Max. motor cable length shielded	m	-	-
Category C2		m	20	20
	RCD (optional)	mA	30	300
RFI filter Low Leakage				
Category C1	Max. motor cable length shielded	m	-	-
		RCD (optional)	mA	-
RFI filter Short Distance				
Category C1	Max. motor cable length shielded	m	25	25
Category C2		m	50	50
	RCD (optional)	mA	30	30
RFI filter Long Distance				
Category C1	Max. motor cable length shielded	m	50	50
Category C2		m	50	100
	RCD (optional)	mA	100	300

# Technical data

3-phase mains connection 400 V "Light Duty"  
RFI filters / Mains filters



## Short distance filter

Inverter	Filter				Max. shielded motor cable length					
	Order code	Rated current	Dimensions (H x W x D)	Weight	C1		C2		C3	
					m	kHz	m	kHz		
i510-C3.0/400-3	I0FAE240F100S0001S	14	346 x 60 x 50	1.42	25	2	50	2	-	-
i510-C3.0/400-3	I0FAE240F100S0001S	14	346 x 60 x 50	1.42	25	4	50	4	-	-
i510-C4.0/400-3	I0FAE240F100S0001S	14	346 x 60 x 50	1.42	25	2	50	2	-	-
i510-C4.0/400-3	I0FAE240F100S0001S	14	346 x 60 x 50	1.42	25	4	50	4	-	-
i510-C5.5/400-3	I0FAE255F100S0001S	18.3	346 x 90 x 60	2.05	25	4	50	4	-	-
i510-C7.5/400-3	I0FAE311F100S0000S	29	371 x 120 x 60	2.35	25	4	50	4	-	-
i510-C11/400-3	I0FAE311F100S0000S	29	371 x 120 x 60	2.35	25	4	50	4	-	-



In order to meet the EMC requirements according to EN IEC 61800-3, the lower of the screws marked "IT" on the product must be removed when using the filters listed below.

Filters:  
I0FAE240F100S0001S  
I0FAE255F100S0001S  
I0FAE311F100S0000S

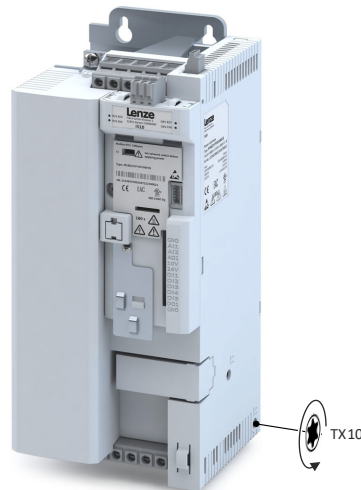

## Long distance filter

Inverter	Filter				Max. shielded motor cable length					
	Order code	Rated current	Dimensions (H x W x D)	Weight	C1		C2		C3	
					m	kHz	m	kHz		
i510-C3.0/400-3	I0FAE240F100D0001S	14	346 x 60 x 50	1.42	50	4	50	4	-	-
i510-C4.0/400-3	I0FAE240F100D0001S	14	346 x 60 x 50	1.42	50	4	50	4	-	-
i510-C5.5/400-3	I0FAE255F100D0001S	18.3	346 x 90 x 60	1.65	50	4	100	4	-	-
i510-C7.5/400-3	I0FAE311F100D0000S	29	371 x 120 x 60	2.05	50	4	100	4	-	-
i510-C11/400-3	I0FAE311F100D0000S	29	371 x 120 x 60	2.05	50	4	100	4	-	-



## Technical data

3-phase mains connection 480 V  
Rated data

---

### 3-phase mains connection 480 V

#### Rated data

The output currents apply to these operating conditions:

- At a switching frequency of 2 kHz or 4 kHz: Max. ambient temperature 45 °C.
- At a switching frequency of 8 kHz or 16 kHz: Max. ambient temperature 40 °C.

# Technical data

3-phase mains connection 480 V

Rated data



Inverter			i510-C0.37/400-3	i510-C0.55/400-3	i510-C0.75/400-3	i510-C1.1/400-3
Rated power	P <sub>rated</sub>	kW	0.37	0.55	0.75	1.1
Rated power	P <sub>rated</sub>	hp	0.5	0.75	1	1.5
Mains voltage range			3/PE AC 340 V ... 528 V, 45 Hz ... 65 Hz			
Output voltage			3 AC 0 - 400/480 V			
Rated mains current						
without mains choke		A	1.5	2.1	2.8	3.7
with mains choke		A	1.2	1.7	2.2	2.5
Apparent output power		kVA	0.9	1.2	1.6	2.2
Rated output current						
2 kHz		A	-	1.6	2.1	3
4 kHz		A	1.1	1.6	2.1	3
8 kHz		A	1.1	1.6	2.1	3
16 kHz		A	0.7	1.1	1.4	2
Power loss						
2 kHz		W	-	24	30	38
4 kHz		W	20	25	32	40
8 kHz		W	24	31	40	51
16 kHz		W	24	31	40	51
Overcurrent cycle 180 s						
Max. output current (≤ 8 kHz)		A	1.7	2.4	3.2	4.5
Overload time	T <sub>1</sub>	s	60	60	60	60
Recovery time	T <sub>2</sub>	s	120	120	120	120
Max. output current during the recovery time		A	0.8	1.2	1.6	2.3
Overcurrent cycle 15 s						
Max. output current (≤ 8 kHz)		A	2.2	3.2	4.2	6
Overload time	T <sub>1</sub>	s	3	3	3	3
Recovery time	T <sub>2</sub>	s	12	12	12	12
Max. output current during the recovery time		A	0.8	1.2	1.6	2.3
Cyclic mains switching			3 times per minute			
Brake chopper						
Max. output current			-			
Min. Brake resistor			-			
Max. shielded motor cable length						
without EMC category		m	15	50		
Category C1 (≤ 8 kHz)		m	-			3
Category C2 (≤ 8 kHz)		m	15			20
Category C3 (≤ 8 kHz)		m	15	20		35
Max. Unshielded motor cable length						
without EMC category		m	-			





# Technical data

3-phase mains connection 480 V  
Rated data

Inverter			i510-C1.5/400-3	i510-C2.2/400-3	i510-C3.0/400-3	i510-C4.0/400-3
Rated power	P <sub>rated</sub>	kW	1.5	2.2	3	4
Rated power	P <sub>rated</sub>	hp	2	3	4	5
Mains voltage range			3/PE AC 340 V ... 528 V, 45 Hz ... 65 Hz			
Output voltage			3 AC 0 - 400/480 V			
Rated mains current						
without mains choke		A	4.5	6.5	8	10.5
with mains choke		A	3.1	4.4	5.8	7.5
Apparent output power		kVA	2.6	3.8	4.9	6.4
Rated output current						
2 kHz		A	3.5	4.8	6.3	8.2
4 kHz		A	3.5	4.8	6.3	8.2
8 kHz		A	3.5	4.8	6.3	8.2
16 kHz		A	2.3	3.2	4.2	5.5
Power loss						
2 kHz		W	45	62	79	102
4 kHz		W	48	66	85	110
8 kHz		W	61	85	110	140
16 kHz		W	61	85	109	140
Overcurrent cycle 180 s						
Max. output current (≤ 8 kHz)		A	5.3	7.2	9.5	12.3
Overload time	T <sub>1</sub>	s	60	60	60	60
Recovery time	T <sub>2</sub>	s	120	120	120	120
Max. output current during the recovery time		A	2.6	3.6	4.7	6.2
Overcurrent cycle 15 s						
Max. output current (≤ 8 kHz)		A	7	9.6	12.6	16.4
Overload time	T <sub>1</sub>	s	3	3	3	3
Recovery time	T <sub>2</sub>	s	12	12	12	12
Max. output current during the recovery time		A	2.6	3.6	4.7	6.2
Cyclic mains switching			3 times per minute			
Brake chopper						
Max. output current			-			
Min. Brake resistor			-			
Max. shielded motor cable length						
without EMC category		m	50		100	
Category C1 (≤ 8 kHz)		m	3		-	
Category C2 (≤ 8 kHz)		m	20			
Category C3 (≤ 8 kHz)		m	35			
Max. Unshielded motor cable length						
without EMC category		m	-			

# Technical data

3-phase mains connection 480 V

Rated data



Inverter			i510-C5.5/400-3	i510-C7.5/400-3	i510-C11/400-3
Rated power	P <sub>rated</sub>	kW	5.5	7.5	11
Rated power	P <sub>rated</sub>	hp	7.5	10	15
Mains voltage range			3/PE AC 340 V ... 528 V, 45 Hz ... 65 Hz		
Output voltage			3 AC 0 - 400/480 V		
Rated mains current					
without mains choke		A	14.3	16.6	23.7
with mains choke		A	10.3	13.1	18.6
Apparent output power		kVA	8.7	11	16
Rated output current					
2 kHz		A	11	14	21
4 kHz		A	11	14	21
8 kHz		A	11	14	21
16 kHz		A	7.3	9.3	14
Power loss					
2 kHz		W	137	172	242
4 kHz		W	145	185	260
8 kHz		W	190	240	340
16 kHz		W	189	238	337
Overcurrent cycle 180 s					
Max. output current (≤ 8 kHz)		A	16.5	21	31.5
Overload time	T <sub>1</sub>	s	60	60	60
Recovery time	T <sub>2</sub>	s	120	120	120
Max. output current during the recovery time		A	8.3	10.5	15.8
Overcurrent cycle 15 s					
Max. output current (≤ 8 kHz)		A	22	28	42
Overload time	T <sub>1</sub>	s	3	3	3
Recovery time	T <sub>2</sub>	s	12	12	12
Max. output current during the recovery time		A	8.3	10.5	15.8
Cyclic mains switching			3 times per minute		
Brake chopper					
Max. output current			-		
Min. Brake resistor			-		
Max. shielded motor cable length					
without EMC category		m	100		
Category C1 (≤ 8 kHz)		m	-		
Category C2 (≤ 8 kHz)		m	20		
Category C3 (≤ 8 kHz)		m	35	50	
Max. Unshielded motor cable length					
without EMC category		m	-		



**Fusing data (EN 60204-1)**



A residual current device (RCD) is optional.

Fusing data for UL/NEC compliant installations: [▶ Fusing data](#) 44

Inverter	Fuse			Circuit breaker			RCD	
	Max. SCCR	Characteristic	Max. rated current	Max. SCCR	Characteristic	Max. rated current		Type
	kA		A	kA		A	mA	
i510-C0.37/400-3	65	gG/gL, gRL	16	65	B, C	16	≥ 30	Typ B
i510-C0.55/400-3	65	gG/gL, gRL	16	65	B, C	16	≥ 30	Typ B
i510-C0.75/400-3	65	gG/gL, gRL	16	65	B, C	16	≥ 30	Typ B
i510-C1.1/400-3	65	gG/gL, gRL	16	65	B, C	16	≥ 30	Typ B
i510-C1.5/400-3	65	gG/gL, gRL	16	65	B, C	16	≥ 30	Typ B
i510-C2.2/400-3	65	gG/gL, gRL	16	65	B, C	16	≥ 30	Typ B
i510-C3.0/400-3	65	gG/gL, gRL	35	65	B, C	25	≥ 30	Typ B
i510-C4.0/400-3	65	gG/gL, gRL	35	65	B, C	25	≥ 30	Typ B
i510-C5.5/400-3	65	gG/gL, gRL	25	65	B, C	25	≥ 300	Typ B
i510-C7.5/400-3	65	gG/gL, gRL	40	65	B, C	40	≥ 30	Typ B
i510-C11/400-3	65	gG/gL, gRL	40	65	B, C	40	≥ 30	Typ B

# Technical data

3-phase mains connection 480 V  
Connection data



## Connection data

Rated power	P <sub>rated</sub>	kW	0.37 ... 2.2	3 ... 4	5.5	7.5 ... 11
Connection description			<b>Mains connection</b>			
Connection			<b>X100</b>			
Connection type			Pluggable		Non-pluggable	
Max. Cable cross-section		mm <sup>2</sup>	2.5	4	6	16
Max. Cable cross-section		AWG	12	10	10	6
Stripping length		mm	8	8	9	11
Stripping length		in	0.3	0.3	0.35	0.43
Tightening torque		Nm	0.5	0.6	0.5	1.2
Tightening torque		lb-in	4.4	5.3	4.4	11
Required tool			Screwdriver 0.5 x 3.0		Screwdriver 0.6 x 3.5	Screwdriver 0.8 x 4.0

Rated power	P <sub>rated</sub>	kW	0.37 ... 5.5	7.5 ... 11
Connection description			<b>PE connection</b>	
Terminal type			<b>Schraube</b>	
Max. Cable cross-section		mm <sup>2</sup>	6	16
Max. Cable cross-section		AWG	10	6
Stripping length		mm	10	11
Stripping length		in	0.4	0.4
Tightening torque		Nm	2	3.4
Tightening torque		lb-in	18	30
Required tool			Torx key 20	Crosstip screwdriver PZ2

Rated power	P <sub>rated</sub>	kW	0.37 ... 4	5.5	7.5 ... 11
Connection description			<b>Motor connection</b>		
Connection			<b>X105</b>		
Connection type			Pluggable	Non-pluggable	
Max. Cable cross-section		mm <sup>2</sup>	2.5	6	16
Max. Cable cross-section		AWG	12	10	6
Stripping length		mm	8	9	11
Stripping length		in	0.3	0.35	0.43
Tightening torque		Nm	0.5	0.5	1.2
Tightening torque		lb-in	4.4	4.4	11
Required tool			Screwdriver 0.5 x 3.0	Screwdriver 0.6 x 3.5	Screwdriver 0.8 x 4.0

The connection data for the terminal X3 can be found under: [▶ Control connections 55](#)



## RFI filters / Mains filters

Basic information on RFI filters, mains filters and EMC: from [138](#)



EMC filters can be used both in the side structure and in the substructure.

### Maximum motor cable lengths with residual current device (RCD)

Mains connection			3-phase, 400 V/480 V			
Inverter			i510-C0.37/400-3	i510-C0.55/400-3 i510-C0.75/400-3	i510-C1.1/400-3 i510-C1.5/400-3 i510-C2.2/400-3 i510-C3.0/400-3 i510-C4.0/400-3	i510-C5.5/400-3 i510-C7.5/400-3 i510-C11/400-3
Without RFI filter						
Without EMC category Thermal limitation	Max. motor cable length shielded	m	15	50	50	100
	Max. motor cable length unshielded	m	30	100	200	200
With integrated RFI filter						
Category C1	Max. motor cable length shielded	m	-	-	-	-
Category C2		m	15	15	20	20
		RCD (optional)	mA	30	30	30
RFI filter Low Leakage						
Category C1	Max. motor cable length shielded	m	-	-	-	-
		RCD (optional)	mA	-	-	-
RFI filter Short Distance						
Category C1	Max. motor cable length shielded	m	15	25	25	25
Category C2		m	15	50	50	50
		RCD (optional)	mA	30	30	30
RFI filter Long Distance						
Category C1	Max. motor cable length shielded	m	15	50	50	50
Category C2		m	15	50	50	100
		RCD (optional)	mA	300	300	300

# Technical data

3-phase mains connection 480 V  
RFI filters / Mains filters



## Short distance filter

Inverter	Filter				Max. shielded motor cable length					
	Order code	Rated current A	Dimensions (H x W x D) mm	Weight kg	C1		C2		C3	
					m	kHz	m	kHz		
i510-C0.37/400-3	IOFAE175F100S0000S	3.3	276 x 60 x 50	0.82	15	4	15	4	-	-
i510-C0.37/400-3	IOFAE175F100S0000S	3.3	276 x 60 x 50	0.82	15	8	15	8	-	-
i510-C0.37/400-3	IOFAE175F100S0000S	3.3	276 x 60 x 50	0.82	15	16	15	16	-	-
i510-C0.55/400-3	IOFAE175F100S0000S	3.3	276 x 60 x 50	0.82	25	2	50	2	-	-
i510-C0.55/400-3	IOFAE175F100S0000S	3.3	276 x 60 x 50	0.82	25	4	50	4	-	-
i510-C0.55/400-3	IOFAE175F100S0000S	3.3	276 x 60 x 50	0.82	25	8	50	8	-	-
i510-C0.55/400-3	IOFAE175F100S0000S	3.3	276 x 60 x 50	0.82	25	16	50	16	-	-
i510-C0.75/400-3	IOFAE175F100S0000S	3.3	276 x 60 x 50	0.82	25	2	50	2	-	-
i510-C0.75/400-3	IOFAE175F100S0000S	3.3	276 x 60 x 50	0.82	25	4	50	4	-	-
i510-C0.75/400-3	IOFAE175F100S0000S	3.3	276 x 60 x 50	0.82	25	8	50	8	-	-
i510-C0.75/400-3	IOFAE175F100S0000S	3.3	276 x 60 x 50	0.82	25	16	50	16	-	-
i510-C1.1/400-3	IOFAE222F100S0000S	7.8	346 x 60 x 50	1.01	25	2	50	2	-	-
i510-C1.1/400-3	IOFAE222F100S0000S	7.8	346 x 60 x 50	1.01	25	4	50	4	-	-
i510-C1.1/400-3	IOFAE222F100S0000S	7.8	346 x 60 x 50	1.01	25	8	50	8	-	-
i510-C1.1/400-3	IOFAE222F100S0000S	7.8	346 x 60 x 50	1.01	25	16	50	16	-	-
i510-C1.5/400-3	IOFAE222F100S0000S	7.8	346 x 60 x 50	1.01	25	2	50	2	-	-
i510-C1.5/400-3	IOFAE222F100S0000S	7.8	346 x 60 x 50	1.01	25	4	50	4	-	-
i510-C1.5/400-3	IOFAE222F100S0000S	7.8	346 x 60 x 50	1.01	25	8	50	8	-	-
i510-C1.5/400-3	IOFAE222F100S0000S	7.8	346 x 60 x 50	1.01	25	16	50	16	-	-
i510-C2.2/400-3	IOFAE222F100S0000S	7.8	346 x 60 x 50	1.01	25	2	50	2	-	-
i510-C2.2/400-3	IOFAE222F100S0000S	7.8	346 x 60 x 50	1.01	25	4	50	4	-	-
i510-C2.2/400-3	IOFAE222F100S0000S	7.8	346 x 60 x 50	1.01	25	8	50	8	-	-
i510-C2.2/400-3	IOFAE222F100S0000S	7.8	346 x 60 x 50	1.01	25	16	50	16	-	-
i510-C3.0/400-3	IOFAE240F100S0001S	14	346 x 60 x 50	1.42	25	2	50	2	-	-
i510-C3.0/400-3	IOFAE240F100S0001S	14	346 x 60 x 50	1.42	25	4	50	4	-	-
i510-C3.0/400-3	IOFAE240F100S0001S	14	346 x 60 x 50	1.42	25	8	50	8	-	-
i510-C3.0/400-3	IOFAE240F100S0001S	14	346 x 60 x 50	1.42	25	16	50	16	-	-
i510-C4.0/400-3	IOFAE240F100S0001S	14	346 x 60 x 50	1.42	25	2	50	2	-	-
i510-C4.0/400-3	IOFAE240F100S0001S	14	346 x 60 x 50	1.42	25	4	50	4	-	-
i510-C4.0/400-3	IOFAE240F100S0001S	14	346 x 60 x 50	1.42	25	8	50	8	-	-
i510-C4.0/400-3	IOFAE240F100S0001S	14	346 x 60 x 50	1.42	25	16	50	16	-	-
i510-C5.5/400-3	IOFAE255F100S0001S	18.3	346 x 90 x 60	2.05	25	4	50	4	-	-
i510-C5.5/400-3	IOFAE255F100S0001S	18.3	346 x 90 x 60	2.05	25	8	50	8	-	-
i510-C7.5/400-3	IOFAE311F100S0000S	29	371 x 120 x 60	2.35	25	4	50	4	-	-
i510-C7.5/400-3	IOFAE311F100S0000S	29	371 x 120 x 60	2.35	25	8	50	8	-	-
i510-C11/400-3	IOFAE311F100S0000S	29	371 x 120 x 60	2.35	25	4	50	4	-	-
i510-C11/400-3	IOFAE311F100S0000S	29	371 x 120 x 60	2.35	25	8	50	8	-	-



In order to meet the EMC requirements according to EN IEC 61800-3, the lower of the screws marked "IT" on the product must be removed when using the filters listed below.

**Filters:**  
IOFAE240F100S0001S  
IOFAE255F100S0001S  
IOFAE311F100S0000S

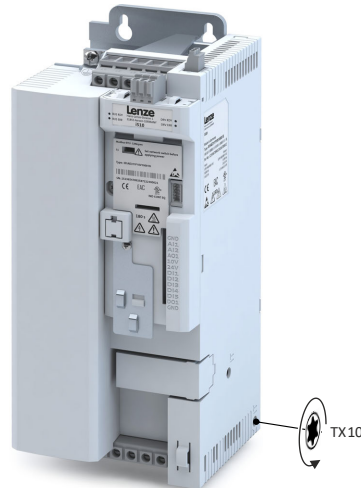

**Long Distance filter**

Inverter	Order code	Filter			Max. shielded motor cable length					
		Rated current A	Dimensions (H x W x D) mm	Weight kg	C1		C2		C3	
					m	kHz	m	kHz		
i510-C0.37/400-3	IOFAE175F100D0000S	3.3	276 x 60 x 50	0.86	15	4	15	4	-	-
i510-C0.37/400-3	IOFAE175F100D0000S	3.3	276 x 60 x 50	0.86	15	8	15	8	-	-
i510-C0.55/400-3	IOFAE175F100D0000S	3.3	276 x 60 x 50	0.86	50	4	50	4	-	-
i510-C0.55/400-3	IOFAE175F100D0000S	3.3	276 x 60 x 50	0.86	50	8	50	8	-	-
i510-C0.75/400-3	IOFAE175F100D0000S	3.3	276 x 60 x 50	0.86	50	4	50	4	-	-
i510-C0.75/400-3	IOFAE175F100D0000S	3.3	276 x 60 x 50	0.86	50	8	50	8	-	-
i510-C1.1/400-3	IOFAE222F100D0000S	7.8	346 x 60 x 50	1.03	50	4	50	4	-	-
i510-C1.1/400-3	IOFAE222F100D0000S	7.8	346 x 60 x 50	1.03	50	8	50	8	-	-
i510-C1.5/400-3	IOFAE222F100D0000S	7.8	346 x 60 x 50	1.03	50	4	50	4	-	-
i510-C1.5/400-3	IOFAE222F100D0000S	7.8	346 x 60 x 50	1.03	50	8	50	8	-	-
i510-C2.2/400-3	IOFAE222F100D0000S	7.8	346 x 60 x 50	1.03	50	4	50	4	-	-
i510-C2.2/400-3	IOFAE222F100D0000S	7.8	346 x 60 x 50	1.03	50	8	50	8	-	-
i510-C3.0/400-3	IOFAE240F100D0001S	14	346 x 60 x 50	1.42	50	4	50	4	-	-
i510-C3.0/400-3	IOFAE240F100D0001S	14	346 x 60 x 50	1.42	50	8	50	8	-	-
i510-C4.0/400-3	IOFAE240F100D0001S	14	346 x 60 x 50	1.42	50	4	50	4	-	-
i510-C4.0/400-3	IOFAE240F100D0001S	14	346 x 60 x 50	1.42	50	8	50	8	-	-
i510-C5.5/400-3	IOFAE255F100D0001S	18.3	346 x 90 x 60	1.65	50	4	100	4	-	-
i510-C5.5/400-3	IOFAE255F100D0001S	18.3	346 x 90 x 60	1.65	50	8	100	8	-	-
i510-C7.5/400-3	IOFAE311F100D0000S	29	371 x 120 x 60	2.05	50	4	100	4	-	-
i510-C7.5/400-3	IOFAE311F100D0000S	29	371 x 120 x 60	2.05	50	8	100	8	-	-
i510-C11/400-3	IOFAE311F100D0000S	29	371 x 120 x 60	2.05	50	4	100	4	-	-
i510-C11/400-3	IOFAE311F100D0000S	29	371 x 120 x 60	2.05	50	8	100	8	-	-



## Technical data

3-phase mains connection 480 V "Light Duty"  
Rated data

---

### 3-phase mains connection 480 V "Light Duty"

#### Rated data

The output currents apply to these operating conditions:

- At a switching frequency of 2 kHz or 4 kHz: Ambient temperature above 40 °C with a rated output current reduced by 2.5 %/°C.
- If the load characteristic "Light Duty" and the switching frequencies 8 kHz or 16 kHz are selected, only the values of the load characteristic "Heavy Duty" are reached.





# Technical data

3-phase mains connection 480 V "Light Duty"  
Rated data

Inverter			i510-C3.0/400-3	i510-C4.0/400-3	i510-C5.5/400-3	i510-C7.5/400-3
Rated power	P <sub>rated</sub>	kW	4	5.5	7.5	11
Rated power	P <sub>rated</sub>	hp	5	7.5	10	15
Mains voltage range			3/PE AC 340 V ... 528 V, 45 Hz ... 65 Hz			
Output voltage			3 AC 0 - 400/480 V			
Rated mains current						
without mains choke		A	8.6	11.2	15.3	22
with mains choke		A	6.8	8.8	12.1	17.2
Apparent output power		kVA	5.9	8	10.5	15
Rated output current						
2 kHz		A	7.6	9.8	13.2	18.3
4 kHz		A	7.6	9.8	13.2	18.3
8 kHz		A	-			
16 kHz		A	-			
Power loss						
2 kHz		W	94	125	163	238
4 kHz		W	100	133	173	253
8 kHz		W	-			
16 kHz		W	-			
Overcurrent cycle 180 s						
Max. output current (≤ 8 kHz)		A	9.5	12.3	16.5	21
Overload time	T <sub>1</sub>	s	60	60	60	60
Recovery time	T <sub>2</sub>	s	120	120	120	120
Max. output current during the recovery time		A	4.7	6.2	8.3	10.5
Overcurrent cycle 15 s						
Max. output current (≤ 8 kHz)		A	12.6	16.4	22	28
Overload time	T <sub>1</sub>	s	3	3	3	3
Recovery time	T <sub>2</sub>	s	12	12	12	12
Max. output current during the recovery time		A	4.7	6.2	8.3	10.5
Cyclic mains switching			3 times per minute			
Brake chopper						
Max. output current			-			
Min. Brake resistor			-			
Max. shielded motor cable length						
without EMC category		m	100			
Category C1 (≤ 8 kHz)		m	-			
Category C2 (≤ 8 kHz)		m	20			
Category C3 (≤ 8 kHz)		m	35			50
Max. Unshielded motor cable length						
without EMC category		m	-			

# Technical data

3-phase mains connection 480 V "Light Duty"

Rated data



Inverter			i510-C11/400-3
Rated power	$P_{rated}$	kW	15
Rated power	$P_{rated}$	hp	20
Mains voltage range			3/PE AC 340 V ... 528 V, 45 Hz ... 65 Hz
Output voltage			3 AC 0 - 400/480 V
Rated mains current			
without mains choke		A	-
with mains choke		A	22.6
Apparent output power		kVA	19
Rated output current			
2 kHz		A	25.2
4 kHz		A	25.2
8 kHz		A	-
16 kHz		A	-
Power loss			
2 kHz		W	290
4 kHz		W	309
8 kHz		W	-
16 kHz		W	-
Overcurrent cycle 180 s			
Max. output current ( $\leq 8$ kHz)		A	31.5
Overload time	$T_1$	s	60
Recovery time	$T_2$	s	120
Max. output current during the recovery time		A	15.8
Overcurrent cycle 15 s			
Max. output current ( $\leq 8$ kHz)		A	42
Overload time	$T_1$	s	3
Recovery time	$T_2$	s	12
Max. output current during the recovery time		A	15.8
Cyclic mains switching			3 times per minute
Brake chopper			
Max. output current			-
Min. Brake resistor			-
Max. shielded motor cable length			
without EMC category		m	100
Category C1 ( $\leq 8$ kHz)		m	-
Category C2 ( $\leq 8$ kHz)		m	20
Category C3 ( $\leq 8$ kHz)		m	50
Max. Unshielded motor cable length			
without EMC category		m	-



### Fusing data (EN 60204-1)



A residual current device (RCD) is optional.

Fusing data for UL/NEC compliant installations: [▶ Fusing data](#) 44

Inverter	Fuse			Circuit breaker			RCD	
	Max. SCCR	Characteristic	Max. rated current	Max. SCCR	Characteristic	Max. rated current		Type
	kA		A	kA		A	mA	
i510-C3.0/400-3	65	gG/gL, gRL	35	65	B, C	25	≥ 30	Typ B
i510-C4.0/400-3	65	gG/gL, gRL	35	65	B, C	25	≥ 30	Typ B
i510-C5.5/400-3	65	gG/gL, gRL	25	65	B, C	25	≥ 300	Typ B
i510-C7.5/400-3	65	gG/gL, gRL	40	65	B, C	40	≥ 30	Typ B
i510-C11/400-3	65	gG/gL, gRL	40	65	B, C	40	≥ 30	Typ B

### Connection data

See "3-phase mains connection 480 V" [▶ Connection data](#) 100

The connection data for the terminal X3 can be found under: [▶ Control connections](#) 55

# Technical data

3-phase mains connection 480 V "Light Duty"  
RFI filters / Mains filters



## RFI filters / Mains filters

Basic information on RFI filters, mains filters and EMC: from [138](#)



EMC filters can be used both in the side structure and in the substructure.

### Maximum motor cable lengths with residual current device (RCD)

Mains connection			3-phase, 400 V/480 V	
Inverter			i510-C3.0/400-3 i510-C4.0/400-3	i510-C5.5/400-3 i510-C7.5/400-3 i510-C11/400-3
Without RFI filter				
Without EMC category Thermal limitation	Max. motor cable length shielded	m	50	100
	Max. motor cable length unshielded	m	200	200
With integrated RFI filter				
Category C1	Max. motor cable length shielded	m	-	-
Category C2		m	20	20
	RCD (optional)	mA	30	300
RFI filter Low Leakage				
Category C1	Max. motor cable length shielded	m	-	-
		RCD (optional)	mA	-
RFI filter Short Distance				
Category C1	Max. motor cable length shielded	m	25	25
Category C2		m	50	50
	RCD (optional)	mA	30	30
RFI filter Long Distance				
Category C1	Max. motor cable length shielded	m	50	50
Category C2		m	50	100
	RCD (optional)	mA	100	300



**Short distance filter**

Inverter	Filter				Max. shielded motor cable length					
	Order code	Rated current	Dimensions (H x W x D)	Weight	C1		C2		C3	
		A	mm	kg	m	kHz	m	kHz		
i510-C3.0/400-3	I0FAE240F100S0001S	14	346 x 60 x 50	1.42	25	2	50	2	-	-
i510-C3.0/400-3	I0FAE240F100S0001S	14	346 x 60 x 50	1.42	25	4	50	4	-	-
i510-C4.0/400-3	I0FAE240F100S0001S	14	346 x 60 x 50	1.42	25	2	50	2	-	-
i510-C4.0/400-3	I0FAE240F100S0001S	14	346 x 60 x 50	1.42	25	4	50	4	-	-
i510-C5.5/400-3	I0FAE255F100S0001S	18.3	346 x 90 x 60	2.05	25	4	50	4	-	-
i510-C7.5/400-3	I0FAE311F100S0000S	29	371 x 120 x 60	2.35	25	4	50	4	-	-
i510-C11/400-3	I0FAE311F100S0000S	29	371 x 120 x 60	2.35	25	4	50	4	-	-



In order to meet the EMC requirements according to EN IEC 61800-3, the lower of the screws marked "IT" on the product must be removed when using the filters listed below.

**Filters:**  
I0FAE240F100S0001S  
I0FAE255F100S0001S  
I0FAE311F100S0000S

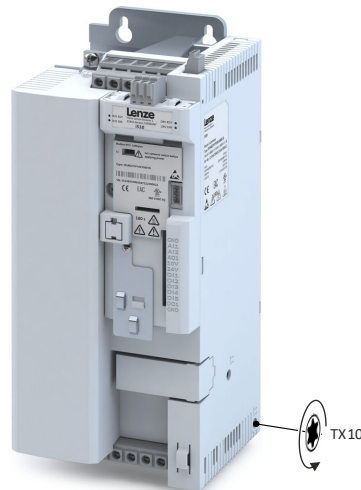

**Long distance filter**

Inverter	Filter				Max. shielded motor cable length					
	Order code	Rated current	Dimensions (H x W x D)	Weight	C1		C2		C3	
		A	mm	kg	m	kHz	m	kHz		
i510-C3.0/400-3	I0FAE240F100D0001S	14	346 x 60 x 50	1.42	50	4	50	4	-	-
i510-C4.0/400-3	I0FAE240F100D0001S	14	346 x 60 x 50	1.42	50	4	50	4	-	-
i510-C5.5/400-3	I0FAE255F100D0001S	18.3	346 x 90 x 60	1.65	50	4	100	4	-	-
i510-C7.5/400-3	I0FAE311F100D0000S	29	371 x 120 x 60	2.05	50	4	100	4	-	-
i510-C11/400-3	I0FAE311F100D0000S	29	371 x 120 x 60	2.05	50	4	100	4	-	-



## Ecodesign Directive

Product information acc. to REGULATION (EU) 2019/1781 (ANNEX I, Section 4)

### Legend

Operating point (f; I) f = relative motor stator frequency; I = relative torque-producing current

Power losses The power losses at the operating points (f; I) and in the standby state refer to the rated apparent output power.  
The power losses for options (e.g. for diagnostics) and for accessories can be found in the additional product documentation on the Internet.

Performance losses										
0; 25	f; I	%	2.2	2.2	1.8	1.8	1.6	1.8	1.1	1.1
0; 50	f; I	%	2.2	2.2	1.8	1.8	1.7	1.8	1.2	1.2
0; 100	f; I	%	2.4	2.4	2.0	2.0	1.9	2.1	1.5	1.6
50; 25	f; I	%	2.2	2.3	1.8	1.8	1.7	1.9	1.1	1.1
50; 50	f; I	%	2.3	2.3	1.9	1.9	1.7	1.9	1.3	1.3
50; 100	f; I	%	2.6	2.6	2.2	2.2	2.1	2.3	1.7	1.7
90; 50	f; I	%	2.4	2.4	2.0	2.0	1.8	2.0	1.3	1.4
90; 100	f; I	%	2.9	2.8	2.5	2.4	2.3	2.4	1.9	1.9
In standby mode		%	0.9	0.9	0.6	0.6	0.5	0.5	0.4	0.4
Efficiency level			IE2	IE2	IE2	IE2	IE2	IE2	IE2	IE2
Manufacturer			Lenze SE · Hans-Lenze-Str. 1 · 31855 Aerzen · GERMANY							
Commercial register number			Hannover HRB 204803							
Model identifier of the product			I51AE125B	I51AE125D	I51AE137B	I51AE137D	I51AE155B	I51AE155D	I51AE175B	I51AE175D
Apparent output power		kVA	0.6	0.6	0.9	0.9	1.2	1.2	1.6	1.6
Indicative rated output power of the motor		kW	0.25	0.25	0.37	0.37	0.55	0.55	0.75	0.75
Rated output current		A	1.7	1.7	2.4	2.4	3.2	3.2	4.2	4.2
Maximum operating temperature		°C	45							
Rated input frequency		Hz	50							
Rated input voltage		V	230							
Switching frequency		kHz	4							
Rated apparent output power		kVA	0.697	0.697	0.977	0.977	1.19	1.19	1.71	1.71



Performance losses										
0; 25	f; l	%	0.9	1.1	0.8	1.0	0.8	0.9	1.1	0.7
0; 50	f; l	%	1.1	1.3	0.9	1.1	1.0	1.1	1.3	1.0
0; 100	f; l	%	1.4	1.6	1.2	1.4	1.3	1.4	1.8	1.7
50; 25	f; l	%	1.0	1.2	0.8	1.0	0.9	1.0	1.2	0.8
50; 50	f; l	%	1.1	1.4	1.0	1.2	1.1	1.2	1.5	1.1
50; 100	f; l	%	1.6	1.8	1.4	1.6	1.6	1.6	2.2	1.9
90; 50	f; l	%	1.2	1.4	1.1	1.3	1.2	1.3	1.6	1.2
90; 100	f; l	%	1.9	2.0	1.7	1.8	1.9	1.9	2.5	2.3
In standby mode		%	0.3	0.3	0.2	0.2	0.1	0.1	0.1	0.1
Efficiency level			IE2	IE2	IE2	IE2	IE2	IE2	IE2	IE2
Manufacturer			Lenze SE · Hans-Lenze-Str. 1 · 31855 Aerzen · GERMANY							
Commercial register number			Hannover HRB 204803							
Model identifier of the product			I51AE211B	I51AE211D	I51AE215B	I51AE215D	I51AE222B	I51AE222D	I51AE240C	I51AE255C
Apparent output power		kVA	2.2	2.2	2.6	2.6	3.6	3.6	6.4	8.7
Indicative rated output power of the motor		kW	1.1	1.1	1.5	1.5	2.2	2.2	4	5.5
Rated output current		A	6	6	7	7	9.6	9.6	16.5	23
Maximum operating temperature		°C	45							
Rated input frequency		Hz	50							
Rated input voltage		V	230							
Switching frequency		kHz	4							
Rated apparent output power		kVA	2.29	2.29	3.3	3.3	4.44	4.44	7.38	9.95

# Technical data

Ecodesign Directive



Performance losses										
0; 25	f; l	%	3.1	3.3	2.2	1.9	1.2	1.1	1.4	1.2
0; 50	f; l	%	3.1	3.4	2.3	2.0	1.3	1.3	1.5	1.3
0; 100	f; l	%	3.3	3.6	2.6	2.3	1.6	1.6	1.9	1.7
50; 25	f; l	%	3.1	3.4	2.2	1.9	1.3	1.2	1.4	1.2
50; 50	f; l	%	3.2	3.4	2.4	2.1	1.4	1.3	1.6	1.4
50; 100	f; l	%	3.5	3.7	2.8	2.5	1.8	1.8	2.0	1.9
90; 50	f; l	%	3.3	3.5	2.5	2.2	1.5	1.5	1.6	1.5
90; 100	f; l	%	3.7	3.9	2.9	2.8	2.1	2.1	2.1	2.0
In standby mode		%	0.6	0.5	0.4	0.3	0.2	0.1	0.1	0.1
Efficiency level			IE2	IE2	IE2	IE2	IE2	IE2	IE2	IE2
Manufacturer			Lenze SE · Hans-Lenze-Str. 1 · 31855 Aerzen · GERMANY							
Commercial register number			Hannover HRB 204803							
Model identifier of the product			I51AE137F	I51AE155F	I51AE175F	I51AE211F	I51AE215F	I51AE222F	I51BE230F	I51BE240F
Apparent output power		kVA	0.9	1.2	1.6	2.2	2.6	3.8	4.9	6.4
Indicative rated output power of the motor		kW	0.37	0.55	0.75	1.1	1.5	2.2	3	4
Rated output current		A	1.3	1.8	2.4	3.2	3.9	5.6	7.3	9.5
Maximum operating temperature		°C	45							
Rated input frequency		Hz	50							
Rated input voltage		V	400							
Switching frequency		kHz	4							
Rated apparent output power		kVA	0.977	1.19	1.71	2.29	3.3	4.44	5.85	7.38





Performance losses					
0; 25	f; l	%	1.0	0.7	0.5
0; 50	f; l	%	1.1	0.8	0.7
0; 100	f; l	%	1.6	1.2	1.0
50; 25	f; l	%	1.0	0.7	0.6
50; 50	f; l	%	1.2	0.9	0.7
50; 100	f; l	%	1.7	1.4	1.2
90; 50	f; l	%	1.2	0.9	0.8
90; 100	f; l	%	1.9	1.6	1.4
In standby mode		%	0.1	0.0	0.0
Efficiency level			IE2	IE2	IE2
Manufacturer			Lenze SE · Hans-Lenze-Str. 1 · 31855 Aerzen · GERMANY		
Commercial register number			Hannover HRB 204803		
Model identifier of the product			I51AE255F	I51BE275F	I51BE311F
Apparent output power		kVA	8.7	11	16
Indicative rated output power of the motor		kW	5.5	7.5	11
Rated output current		A	13	16.5	23.5
Maximum operating temperature		°C	45		
Rated input frequency		Hz	50		
Rated input voltage		V	400		
Switching frequency		kHz	4		
Rated apparent output power		kVA	9.95	14.4	19.5

## Dimensions



The specified installation clearances are minimum dimensions to ensure a sufficient air circulation for cooling purposes. They do not consider the bend radiuses of the connecting cables.



Several i5xx frequency inverters can be mounted directly next to each other, regardless of the device size. No installation clearance is required between the devices.

### Installation clearances

- Maintain the specified installation clearances above and below to the other installations.
- Several devices of the same series can be lined up directly, regardless of the device size. No installation clearance is required between the devices.

# Technical data

## Dimensions



### 0.25 kW ... 0.37 kW

The dimensions in mm apply to:

0.25 kW	i510-C0.25/230-1	i510-C0.25/230-2	
0.37 kW	i510-C0.37/230-1	i510-C0.37/230-2	i510-C0.37/400-3
Weight	0.75 kg	0.75 kg	0.75 kg

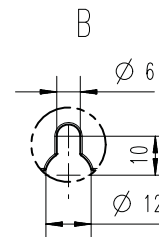
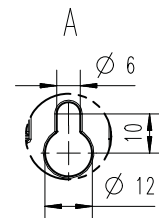
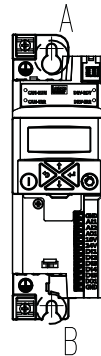
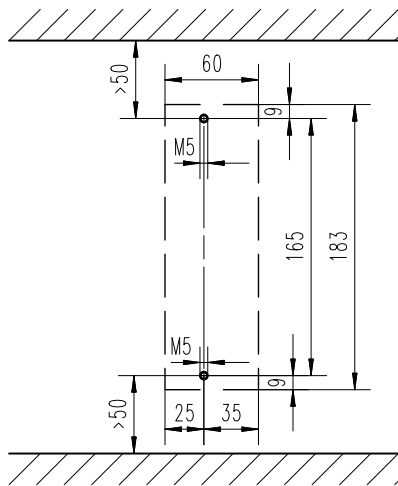
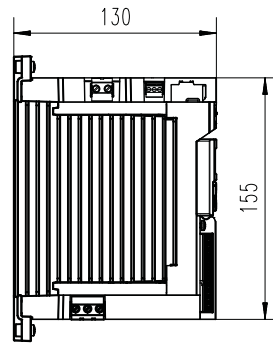
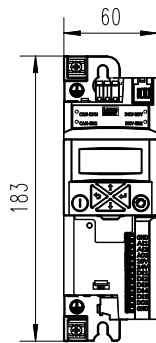

8800270



**0.33 hp ... 0.5 hp**

The dimensions in inch apply to:

0.33 hp	i510-C0.25/230-1	i510-C0.25/230-2	
0.5 hp	i510-C0.37/230-1	i510-C0.37/230-2	i510-C0.37/400-3
Weight	1.7 lb	1.7 lb	1.7 lb

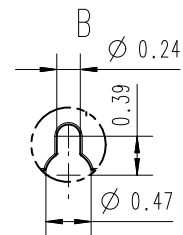
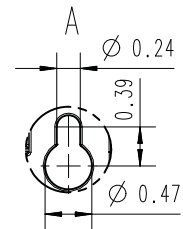
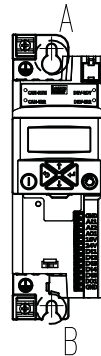
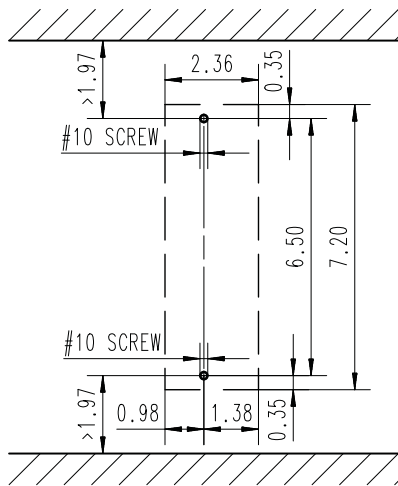
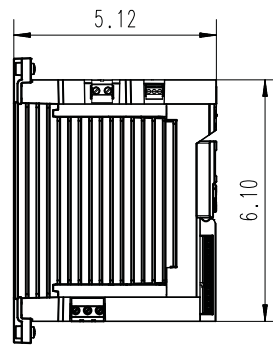
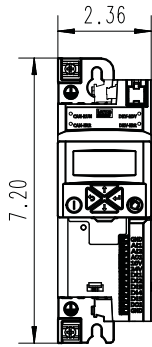

8800305

# Technical data

## Dimensions



### 0.55 kW ... 0.75 kW

The dimensions in mm apply to:

0.55 kW	i510-C0.55/230-1	i510-C0.55/230-2	i510-C0.55/400-3
0.75 kW	i510-C0.75/230-1	i510-C0.75/230-2	i510-C0.75/400-3
Weight	0.95 kg	0.95 kg	0.95 kg

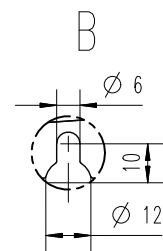
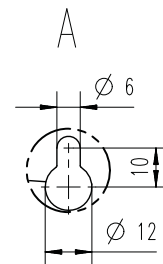
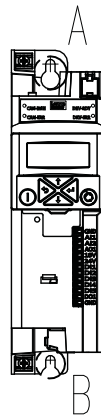
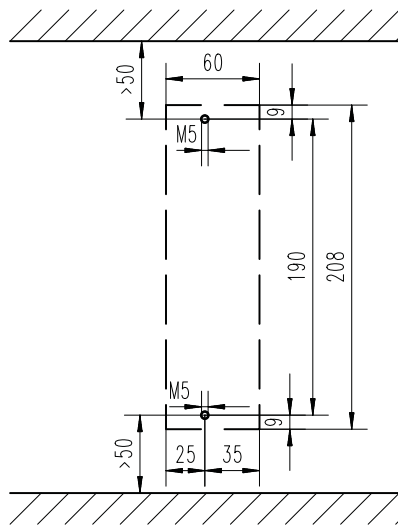
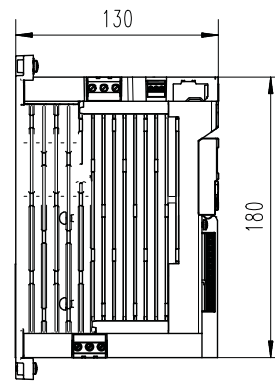
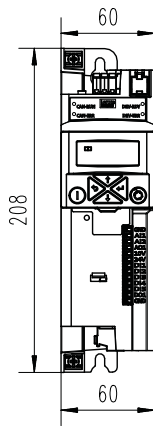

8800271



**0.75 hp ... 1 hp**

The dimensions in inch apply to:

0.75 hp	i510-C0.55/230-1	i510-C0.55/230-2	i510-C0.55/400-3
1 hp	i510-C0.75/230-1	i510-C0.75/230-2	i510-C0.75/400-3
Weight	2.1 lb	2.1 lb	2.1 lb

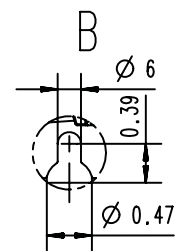
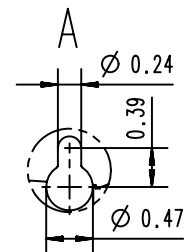
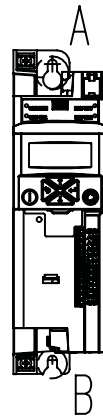
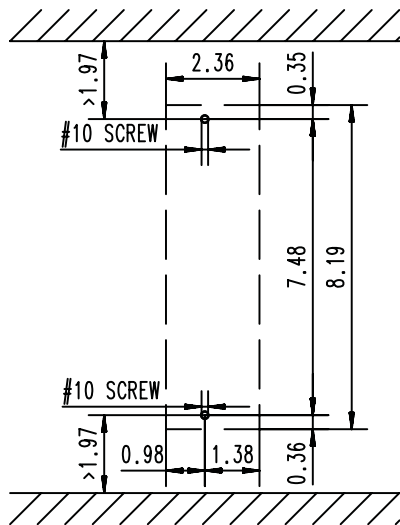
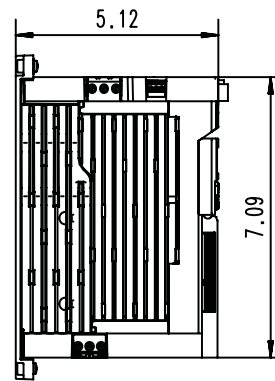
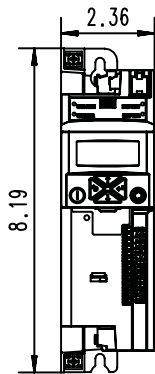

8800306

# Technical data

## Dimensions



### 1.1 kW ... 4 kW

The dimensions in mm apply to:

1.1 kW	i510-C1.1/230-1	i510-C1.1/230-2	i510-C1.1/400-3	
1.5 kW	i510-C1.5/230-1	i510-C1.5/230-2	i510-C1.5/400-3	
2.2 kW	i510-C2.2/230-1	i510-C2.2/230-2	i510-C2.2/400-3	
3 kW				i510-C3.0/400-3
4 kW				i510-C4.0/400-3
Weight	1.35 kg	1.35 kg	1.35 kg	1.35 kg

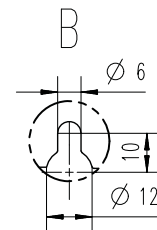
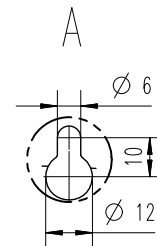
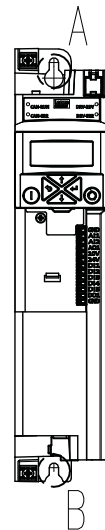
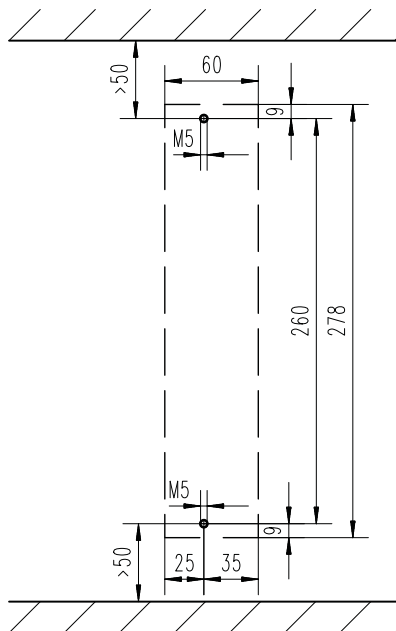
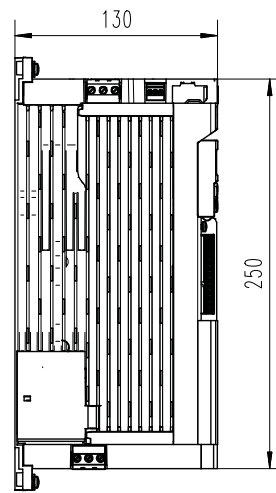
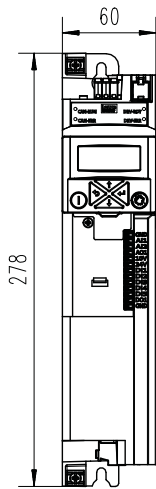

8800272



## 1.5 hp ... 5 hp

The dimensions in inch apply to:

1.5 hp	i510-C1.1/230-1	i510-C1.1/230-2	i510-C1.1/400-3	
2 hp	i510-C1.5/230-1	i510-C1.5/230-2	i510-C1.5/400-3	
3 hp	i510-C2.2/230-1	i510-C2.2/230-2	i510-C2.2/400-3	
4 hp				i510-C3.0/400-3
5 hp				i510-C4.0/400-3
Weight	3 lb	3 lb	3 lb	3 lb

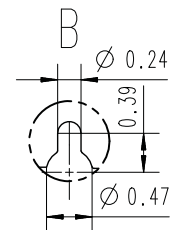
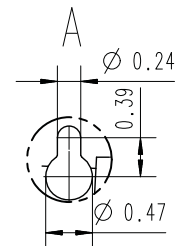
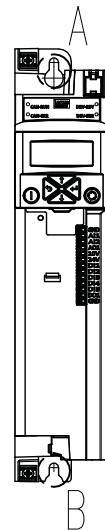
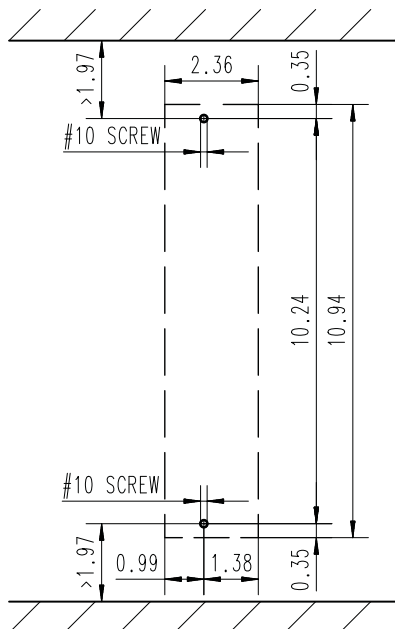
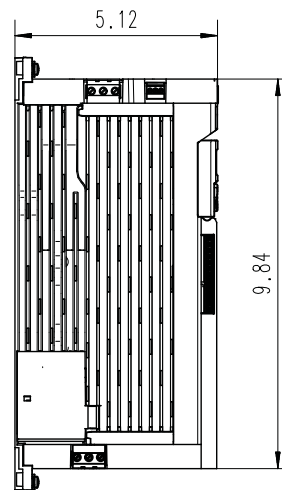
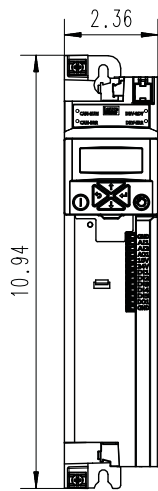

8800307

# Technical data

## Dimensions



### 4 kW ... 5.5 kW

The dimensions in mm apply to:

4 kW	i510-C4.0/230-3	
5.5 kW	i510-C5.5/230-3	i510-C5.5/400-3
Weight	2.1 kg	2.3 kg

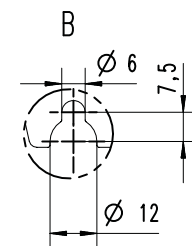
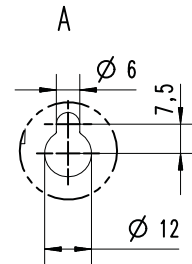
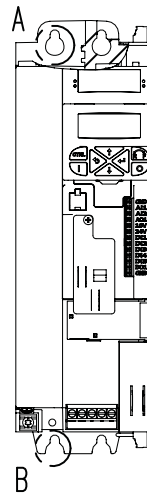
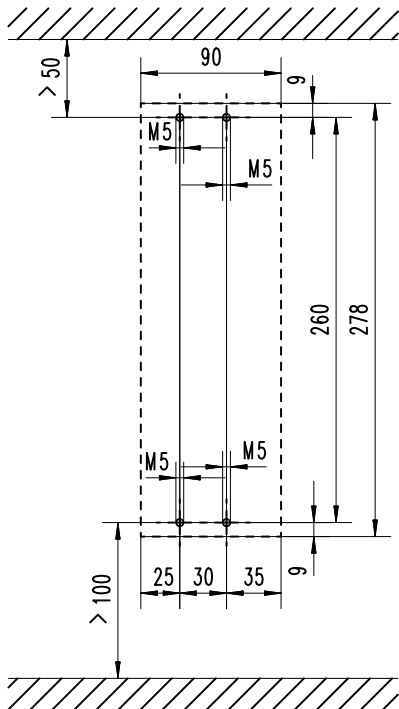
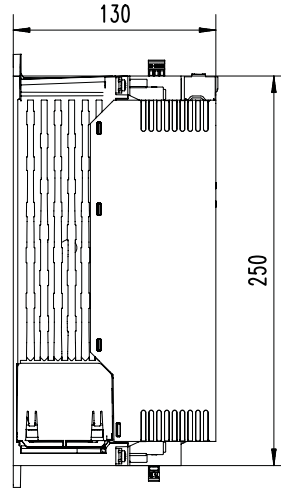
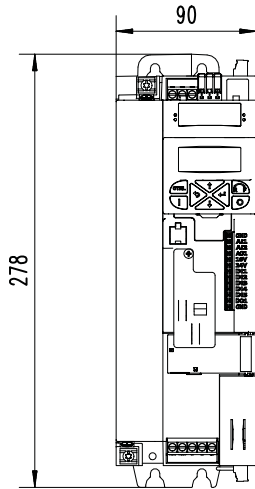

8800599





# Technical data

## Dimensions

### 5 hp ... 7.5 hp

The dimensions in inch apply to:

5 hp	i510-C4.0/230-3	
7.5 hp	i510-C5.5/230-3	i510-C5.5/400-3
Weight	4.6 lb	5 lb

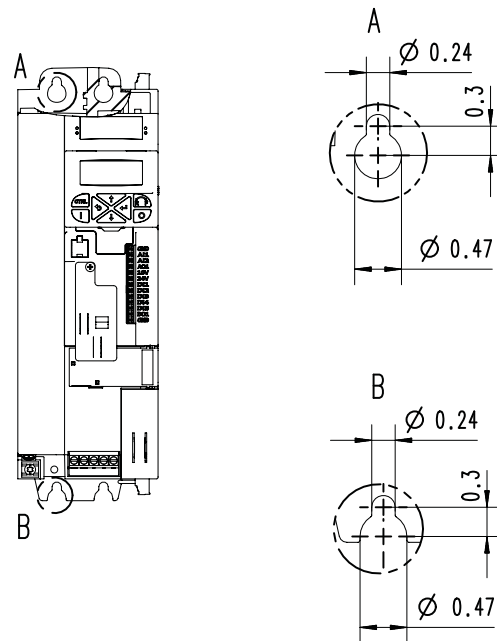
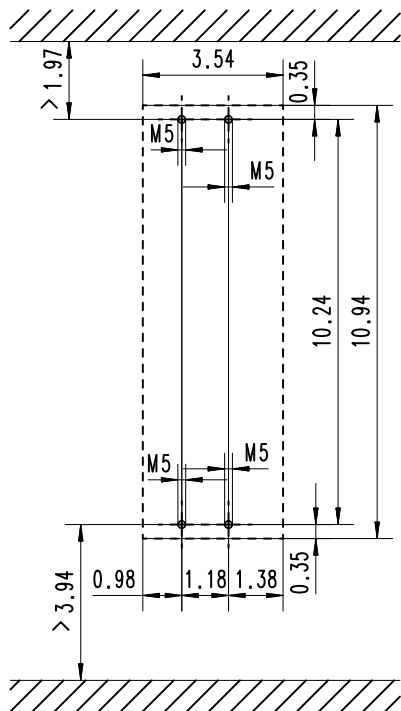
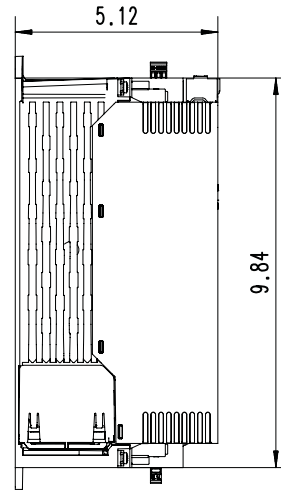
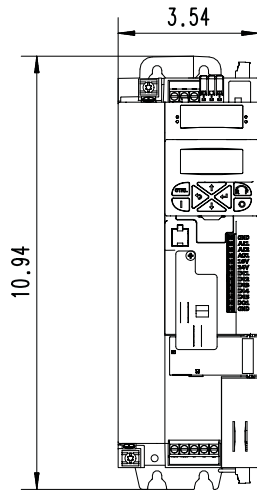

8800601

# Technical data

## Dimensions



### 7.5 kW ... 11 kW

The dimensions in mm apply to:

7.5 kW	i510-C7.5/400-3
11 kW	i510-C11/400-3
Weight	3.7 kg

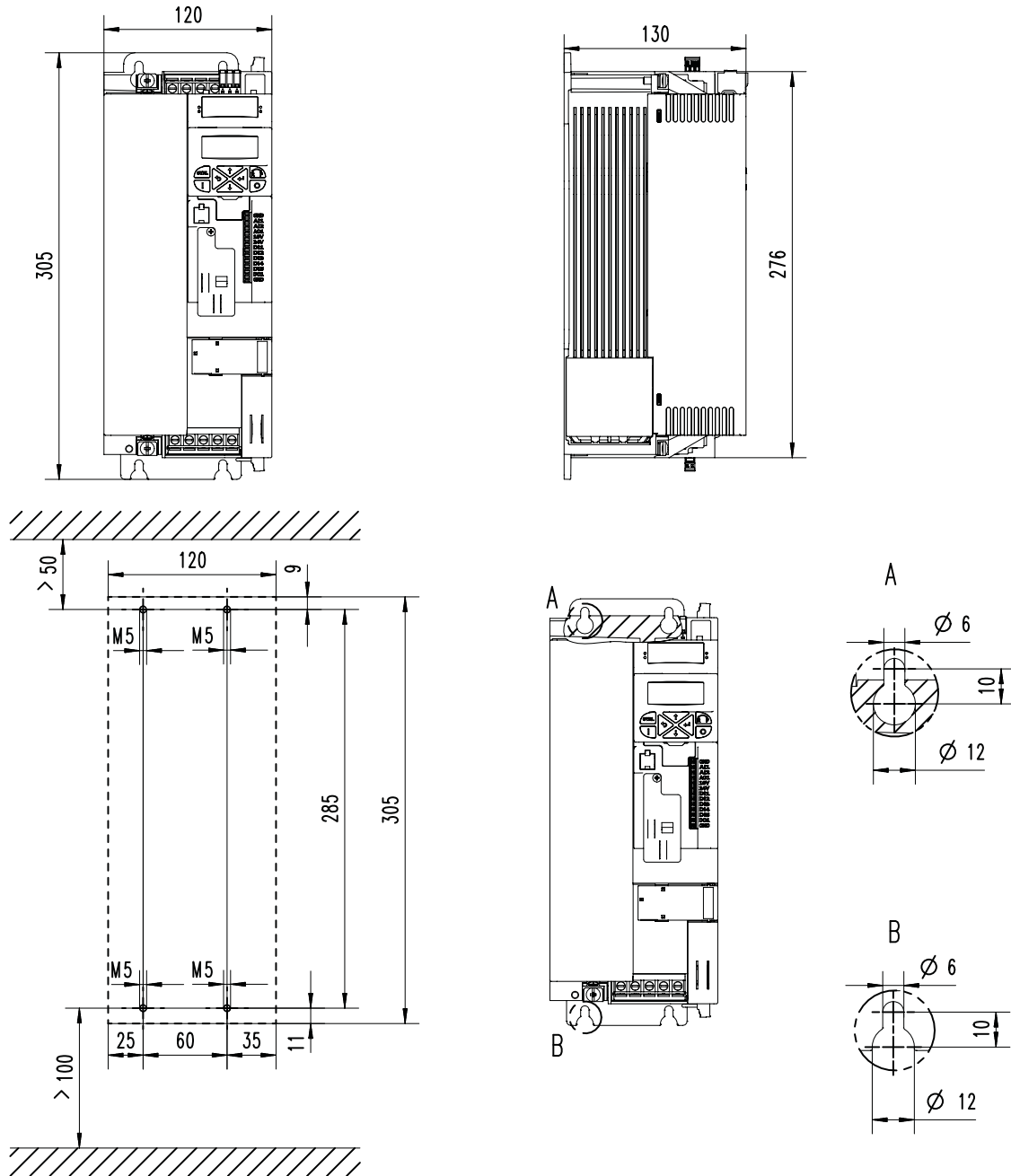

8800600



# Technical data

## Dimensions

### 10 hp ... 15 hp

The dimensions in inch apply to:

10 hp	i510-C7.5/400-3
15 hp	i510-C11/400-3
Weight	8 lb

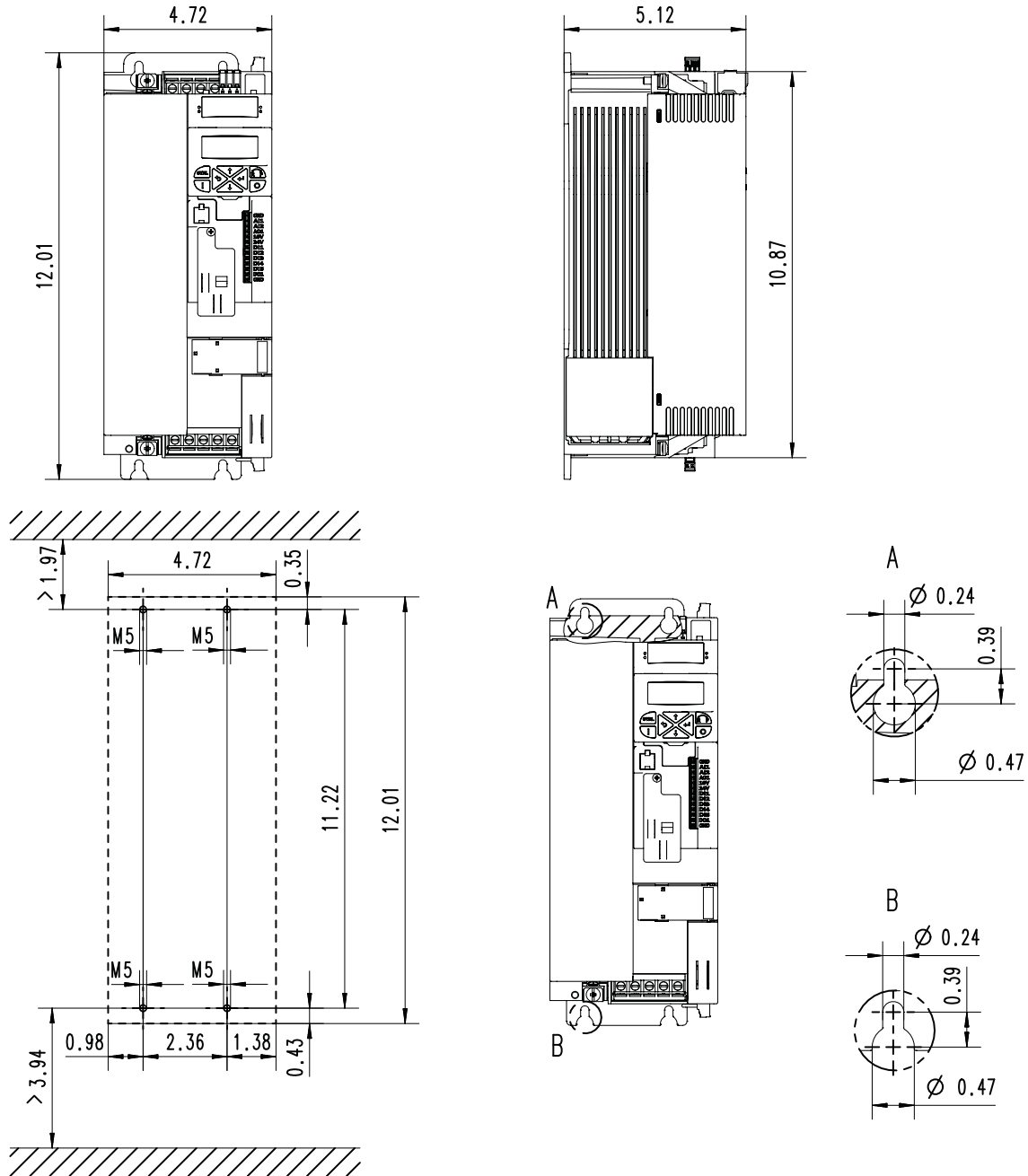

8800602



## Product extensions

### Overview

The inverters can easily be integrated into the machine. The scalable product extensions serve to flexibly match the required functions to your application.

The integrated standard product extension for the i510 inverter is the control unit with basic I/O.

As the control unit cannot be extended, the i510 inverter is available in two versions:

- With CANopen/Modbus, switchable.
- Without network.

In order to provide a largely uniform documentation, all information and data of the control unit with basic I/O are contained here in the "product extension" chapter.



Inverter  
without network



Inverter  
with CANopen and Modbus



## I/O extensions

### Basic I/Os

The basic I/O provides the inverter analog and digital inputs and outputs and is designed for simple applications.

The basic I/O can be purchased with or without the CANopen and Modbus networks. A switch can be used to select between the two networks.

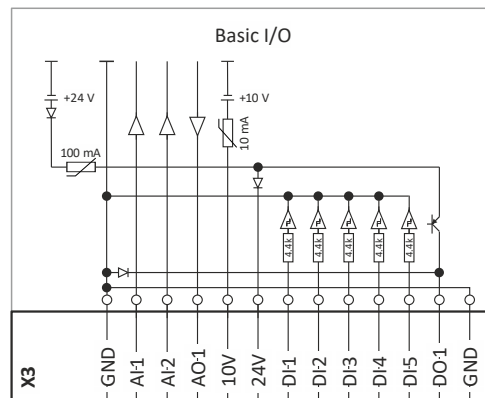

### Description of the control terminals

Input/output	Terminal X3	Information
Digital inputs	DI1, DI2, DI3, DI4, DI5	DI3/DI4 can be optionally used as frequency or encoder input. HIGH active/LOW active switchable LOW = 0 ... +3 V, HIGH = +12 V ... +30 V
	DO1	Digital output (max. 100 mA)
Analog outputs	AI1, AI2	Can be optionally used as voltage input or current input.
	AO1	Can be optionally used as voltage output or current output.
10-V output	10 V	Primarily for the supply of a potentiometer (1 ... 10 kΩ). Max. 10 mA
24-V output	24 V	Primarily for the supply of digital inputs. (Max. 100 mA)
Reference potential	GND	
Connection system	Plug-in spring terminal	

# Product extensions

I/O extensions  
Data of control connections



## Data of control connections

### Digital inputs

Switching type		PNP	
PNP switching level			
LOW	V	< +5	IEC 61131-2, type 1
HIGH	V	> +15	
Input resistance	kΩ	4.6	
Cycle time	ms	1	can be changed by software filtering
Electric strength of external voltage	V	± 30	

### Digital outputs

Switching level			
LOW	V	< +5	IEC 61131-2, type 1
HIGH	V	> +15	
max. output current	mA	100	Total current for DO1 and 24V
Cycle time	ms	1	
Short-circuit strength		Unlimited period	
Electric strength of external voltage	V	± 30	
Polarity reversal protection		Integrated freewheeling diode for switching the inductive load	
Overload behaviour		Reduced voltage or periodic switch-off/on	
Reset or switch-on behaviour		Output is switched off	LOW

### Analog inputs

Cycle time	ms	1	
Resolution of A/D converter	Bit	12	
Operation as voltage input			
Connection designation		X3/AI1, X3/AI2	
Input voltage DC	V	0 ... 10	
Input resistance	kΩ	70	
Accuracy	mV	± 50	Typical
Input voltage in case of open circuit	V	- 0.2 ... 0.2	Display "0"
Electric strength of external voltage	V	± 24	
Operation as current input			
Connection designation		X3/AI1, X3/AI2	
Input current	mA	0 ... 20	
		4 ... 20	open-circuit monitored
Accuracy	mA	± 0.1	Typical
Input current in case of open circuit	mA	< 0.1	Display "0"
Input resistance	Ω	< 250	
Electric strength of external voltage	V	± 24	



## Analog outputs

Short-circuit strength		Unlimited period	
Electric strength of external voltage	V	+ 24V	
Operation as voltage output			
Resolution of D/A converter	Bit	12	
Output voltage DC	V	0 ... 10	
max. output current	mA	5	
min. load resistance	kΩ	≥ 2.2	
max. capacitive load	μF	1	
Accuracy	mV	± 100	Typical
Operation as current output			
Output current	mA	0 ... 20	
		4 ... 20	open-circuit monitored
Accuracy	mA	± 0.3	Typical

## 10-V output

Use		Primarily for the supply of a potentiometer (1 ... 10 kΩ)	
Output voltage DC			
Typical	V	10	
Accuracy	mV	± 100	
Max. output current	mA	10	
Max. capacitive load	μF	1	
Short-circuit strength		Unlimited period	
Electric strength of external voltage	V	+ 24	

## 24-V output

Use		Primarily for the supply of digital inputs	SELV/PELV
Output voltage DC			
Typical	V	24	
Area	V	16 ... 28	
max. output current	mA	100	Total current for DO... and 24V
Short-circuit strength		Unlimited period	
Electric strength of external voltage	V	+ 30	
Excess current release		Automatically resettable	

# Product extensions

Further control connections  
Relay output



## Further control connections

### Relay output



Use a corresponding suppressor circuit in case of an inductive or capacitive load!

Connection		Terminal X9: COM	Common contact (Common)	
		Terminal X9: NC	Normally closed contact	
		Terminal X9: NO	Normally open contact	
Minimum DC contact load				
	Voltage	V	10	A correct switching of the relay contacts needs both values to be exceeded simultaneously.
	Current	mA	10	
Switching voltage/switching current				
Maximum	AC 240 V	A	3	According to UL: General Purpose
	24 V DC	A	2	According to UL: Resistive
	240 V DC	A	0.16	

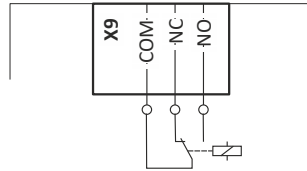





### Networks

The integrated standard product extension for the i510 inverter is the control unit with basic I/O.

As the control unit cannot be extended, the i510 inverter is available in two versions:

- With CANopen/Modbus, switchable.
- Without network.

# Product extensions

Networks  
CANopen



## CANopen

CANopen is an internationally approved communication protocol which is designed for commercial and industrial automation applications. High data transfer rates in connection with efficient data formatting provide for the coordination of motion control devices in multi-axis applications.

Bus-related information			
Name		CANopen CiA 301 V4.2.0	
Communication medium		CAN cable in accordance with ISO 11898-2	
Use		Connection of inverter to a CANopen network	
Connection system		Pluggable double spring terminal	
Status display		2 LEDs	
Connection designation		X216: CH, CL, CG	

Technical data			
Bus terminating resistor	$\Omega$	120	Terminated on both sides
Integrated bus terminating resistor		No	
Network topology			
Without repeater		Line	
With repeater		Line or tree	
Device			
Type		Slave	
Max. number without repeater		127	Per bus segment, incl. host system
Address		1 ... 127	Adjustable via code
Baud rate	kbps	20, 50, 125, 250, 500, 800 or 1000	Adjustable via code
Max. bus length	m	2500, 1000, 500, 250, 100, 50 or 25	Total cable length depends on the baud rate
Max. cable length between two devices		Not limited, the max. bus length is decisive	
Process data			
Transmit PDOs		3 TPDOs with 1 ... 8 Byte (adjustable)	
Receive PDOs		3 RPDOs with 1 ... 8 bytes (adjustable)	
Transmission mode for TPDOs			
With change of data		Yes	
Time-controlled, multiple of	ms	10	
After reception		1 ... 240 sync telegrams	
Parameter data			
SDO channels		Max. 2 servers	

Communication time			
Communication time depends on		Processing time in the inverter	Time between start of a request and arrival of response
		Telegram runtime (baud rate, telegram length)	
		Nesting depth of network	
		Bus load	

Processing time of process data			
Update cycle	ms	10	In inverter
Processing time	ms	0 ... 1	
Application task runtime of the technology application used (tolerance)	ms	1 ... x	

Other data			
Note: There are no interdependencies between parameter data and process data.			



## Modbus RTU

Modbus is an internationally approved, asynchronous, serial communication protocol, designed for commercial and industrial automation applications.

Bus-related information			
Name		Modbus RTU	
Communication medium		RS485 (EIA)	
Use		Connection of inverter to a Modbus network	
Connection system		Pluggable double spring terminal	
Status display		2 LEDs	
Connection designation		X216: TA, TB, COM	

Technical data			
Communication profile		Modbus RTU	
Bus terminating resistor	$\Omega$	120	Terminated on both sides
Integrated bus terminating resistor		No	
Network topology			
Without repeater		Line	
Device			
Type		Slave	
Max. number without repeater		32	Per bus segment, incl. host system
Max. number with repeater		90	
Address		1 ... 247	Adjustable via code
Baud rate	kbps	4.8 ... 115	Adjustable via code
Max. cable length	m	12 ... 600	Per bus segment, depending on the baud rate and the used cable type
Max. cable length between two devices		Not limited, the max. bus length is decisive	
Data channel			
SDO channels		Max. 2 servers, with 1 ... 8 bytes	Supported functions: Read Holding Registers Preset Single Register Preset Multiple Registers Read/Write 4 x registers

Communication time			
Communication time depends on		Processing time in the inverter	Time between start of a request and arrival of response
		Telegram runtime (baud rate, telegram length)	
		Nesting depth of network	
		Bus load	

Processing time of process data			
Update cycle	ms	1	In the inverter
Processing time	ms	0 ... 1	
Application task runtime of the technology application used (tolerance)	ms	1 ... x	

Other data			
Note: There are no interdependencies between parameter data and process data.			



## Accessories

### Overview

A package of accessories optimally matched to the inverter is available for your applications.

Moreover, the pluggable modules make commissioning and diagnostics easier.

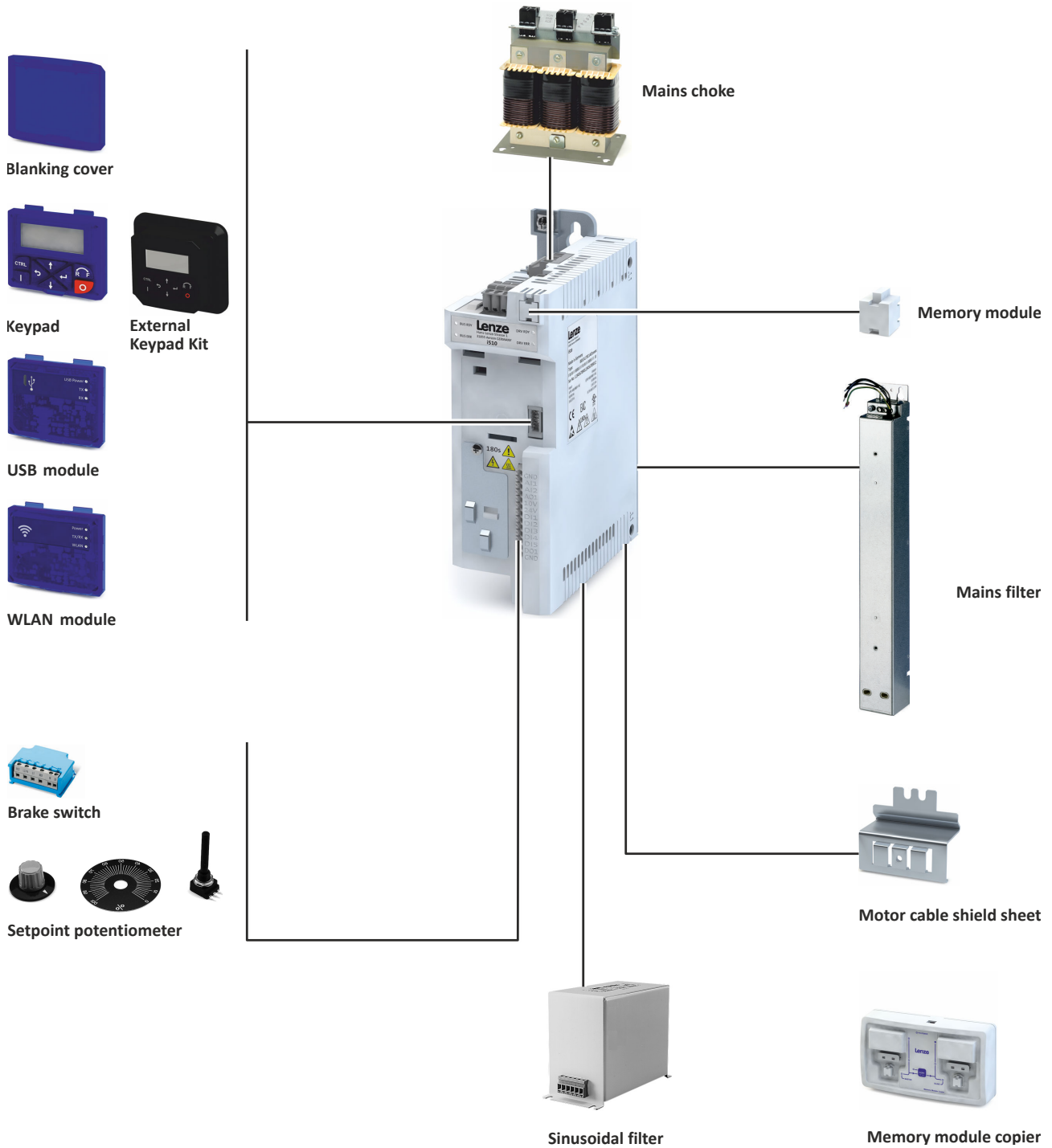

Further accessories: DIN rail



## Operation and diagnostics

### Keypad

Parameter setting and diagnostics

Thanks to the intuitive operating structure, the navigation keys allow a quick and easy access to the most important parameters, either to configure functions or to query current values. Parameters and actual values are indicated on the easy-to-read display.



Keypad	
Order code	Type
I5MADK000000S	LCD display Display in German/English

### External keypad

Installation in user interface

The external keypad kit facilitates installation of a I5MADK000000S keypad in an IP65 housing for mounting to the control cabinet wall.



External keypad kit	
Order code	Type
I5MADR000000S	without connecting cable
I5MADR0000001S	with connecting cable 3 m
I5MADR0000002S	with connecting cable 5 m
The I5MADK000000S keypad is not part of the delivery.	

# Accessories

Operation and diagnostics  
USB module



## USB module

Interface to the PC

Connect the inverter via a USB 2.0 connection cable to a PC on which the Lenze "EASY Starter" engineering tool is installed. Configure the inverter with the "EASY Starter" using graphical user interfaces. You can create diagnostics with trend functions or observe parameter values.

Parameterising without supplying the inverter with voltage: in many cases, the USB interface of the PC is sufficient for the voltage supply if you connect the inverter directly to the PC without a hub.



USB module	
Order code	Version
I5MADU0000000S	Parameterization without voltage supply of the inverter is possible. USB 2.0 connecting cable required

Connecting cable		
Order code	Length	Type
EWL0085/S	3 m	USB 2.0-connecting cable (A-plug to micro B-plug)
EWL0086/S	5 m	



## WLAN module

Communicate wirelessly with the inverter, via a PC using the Lenze Engineering Tool "EASY Starter" or the Lenze "SMART Keypad App" for Android and iOS smartphones.



### **⚠ WARNING!**

- ▶ This product contains FCC ID: QQQWF121/IC: 5123A-BGTWF121
- ▶ To comply with FCC and Industry Canada RF radiation exposure limits for general population, the transmitter with its antenna must be installed such that a minimum separation distance of 20 cm is maintained between the radiator (antenna) and all persons at all times.
- ▶ This product must not be collocated or operated in conjunction with any other antenna or transmitter.
- ▶ -----
- ▶ Le produit contient un module transmetteur certifié FCC ID: QQQWF121/IC: 5123A-BGTWF121
- ▶ Afin de se conformer aux réglementations de la FCC et d'Industry Canada relatives aux limites d'exposition aux rayonnements RF pour le grand public, le transmetteur et son antenne doivent être installés de sorte qu'une distance minimale de 20 cm soit constamment maintenue entre le radiateur (antenne) et toute personne.
- ▶ Le produit ne doit pas être utilisé en combinaison avec d'autres antennes ou transmetteurs.

The module can be used if the certification is recognized in a country according to one of these standards.

Conformity and approvals		
CE	RED	EN 301489-1 V2.1.1:2016
		EN 301489-17 V3.1.1:2016
		EN 300328 V2.1.1:2016
FCC	Part 15.107/15.109 ICES-003	

Additional conformities and approvals:

- IC
- CMIIT

LED status displays			
LED 1	LED 2	LED 3	Meaning
Power (green)	TX/RX (yellow)	WLAN (green)	
Supply voltage status	Communication status	WLAN status	
OFF	OFF	OFF	No voltage
ON	ON	ON	Self-test (approx. 1 s)
ON	OFF	OFF	Ready for operation No active WLAN connection
ON	Flashing	ON	Communication active
ON	OFF	Blinking	Client Mode Waiting for connection
Blinking	OFF	OFF	Trouble

# Accessories

Operation and diagnostics  
Blanking cover



Connection data (default setting)	
IP address	192.168.178.1
SSID	<Product type>_<10-digit identifier>
Password	password

WLAN module	
Order code	Type
I5MADW00000005	Range in open space: 100 m, conditions on site may restrict the range.

## Blanking cover

Protection and optics

The blanking cover protects the terminals and provides for uniform optics if no other module is plugged on.



Blanking cover		
Order code	Type	VPE
		Piece
I5ZAA0000M	Protection against dust Uniform optics	4

## Control and display elements

### Potentiometer

For the external selection of an analog setpoint.

The setpoint selection (e.g. motor speed) can be manually set via the external potentiometer. The potentiometer is connected to the analog input terminals of the inverter.

The position is displayed on the scale via the rotary knob.

The components have to be ordered separately.



Potentiometer		
Order code	Name	Type
ERPD0010K0001W	Potentiometer	10 kΩ/1 W
ERZ0001	Rotary knob	Diameter 36 mm
ERZ0002	Scale	Scale 0 ... 100 %, Diameter 62 mm





## Memory modules

For standard set-up, Lenze offers its customers multipacked, unwritten memory modules (EPM). In combination with the EPM copier, the EPMs can be duplicated at any location.

A memory module is included in the scope of supply of the inverter.

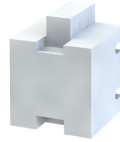

Memory module		
Order code	Type	VPE
		Piece
IOMAPA0000000M	Easily pluggable Duplicate data set with memory module copier	12

## Memory module copier

For duplicating data on memory modules for a faster standard set-up.

The memory module copier is a copying system for all memory modules from Lenze. With the help of simple optical user guidance, the data of a module is copied quickly and reliably to another memory module.



Memory module copiers	
Order code	Type
EZAEDE1001	Data set copier for memory modules

## Mains chokes

- Mains chokes reduce the feedback effects of the inverter on the supplying mains by their high inductive resistance reducing high-frequency interference.
- The effective mains current is reduced which saves energy.
- Mains chokes can be used without restrictions in conjunction with RFI filters.
- Please note that the use of a mains choke reduces the mains voltage at the input of the inverter by 4 % (typical voltage drop across the mains choke in the rated point).



The matching assignment of these accessories is specified in the technical data of the devices.

# Accessories

RFI filters / Mains filters



---

## RFI filters / Mains filters

RFI and mains filters are used to ensure compliance with the EMC requirements of EN IEC 61800-3. This standard defines the EMC requirements for electrical drive system in various categories.

- RFI filters are capacitive accessory components. RFI filters reduce conducted noise emissions. RFI filters are also called EMC filters.
- Mains filters are a combination of mains choke and RFI filter. Mains filters reduce the conducted noise emission.

### Definition of the environments

(EN IEC 61800-3)

#### First environment

The first environment comprises residential buildings or locations that are directly connected to a low-voltage system for supplying residential areas.

#### Second environment

The second environment comprises facilities or locations that are not directly connected to a low-voltage system for supplying residential areas.

#### Category C1

Category C1 defines the requirements for drive systems that are intended for the use in the first environment at a rated voltage lower than 1000 V.

The limit values of the EN IEC 61800-3 comply with EN 55011 class B.

#### Category C2

Category C2 defines the requirements for permanently installed fixed drive systems that are intended for the use in the first environment at a rated voltage lower than 1000 V. Installation and commissioning may only be carried out by specialist personnel with EMC knowledge.

The limit values of the EN IEC 61800-3 comply with EN 55011 class A group 1.

#### Category C3

Category C3 defines the requirements for drive systems that are exclusively intended for the use in the second environment at a rated voltage lower than 1000 V.

The limit values of the EN IEC 61800-3 comply with EN 55011 class A group 2.



When working with stricter line-bound noise emission requirements which cannot be met using the radio interference suppression measures integrated in the inverter, external filters can be used. The filters can be installed below or next to the inverter.

If necessary, the internal filters have to be deactivated when external filters are used. For this purpose, remove the IT screws of the inverters.

---





### Comparison of integrated and external RFI filters

RFI filter	Filter types			
	Integrated in the inverter	External		
		Low Leakage	Short Distance	Long Distance
Use	In standard applications	In mobile systems	With short cable length	At switching frequencies 4 kHz and 8 kHz.
Optimization	Easy use	For low leakage current	For low leakage current	For long motor cable
Reduces noise emissions	Cable-guided and radiated	Cable-guided	Cable-guided	Cable-guided



The matching assignment of these accessories is specified in the technical data of the devices.

### Sine filter

A sinusoidal filter in the motor cable limits the rate of voltage rise and the capacitive charge/discharge currents between the conductors that occur during inverter operation.



Only use a sinusoidal filter with standard asynchronous motors 0 to 550 V.  
Operation only with V/f or square-law V/f characteristic control.  
Set the switching frequency permanently to the specified value.  
Limit the output frequency of the inverter to the given value.



The matching assignment of these accessories is specified in the technical data of the devices.

### Brake switches

For switching an electromechanical brake.

The brake switch consists of a rectifier and an electronic circuit breaker. It is mounted on the control cabinet plate. Control is performed using a digital output on the inverter.



Brake switches		Half-wave rectifiers	Bridge rectifiers
Order code		E82ZWBRE	E82ZWBRB
Input voltage	V	AC 320 - 550	AC 180 - 317
Output voltage	V	DC 180 (with AC 400) DC 225 (with AC 500)	DC 205 (with AC 230)
Max. brake current	A	0.61	0.54

# Accessories

Mounting  
Shield mounting kit



## Mounting

### Shield mounting kit

#### Motor cable

If the shielding of the motor cable is centrally connected to an earthing busbar in the control cabinet, no shielding is required.

For a direct connection of the shielding of the motor cable to the inverter, the optionally available accessories can be used consisting of shield sheet and fixing clips or wire clamps.

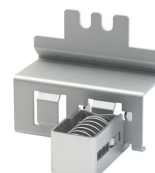

Inverter	Shield mounting kit			
	Order code	Packaging unit Unit	Order code	Packaging unit Unit
i510-C0.25/230-1	EZAMBHXM018/M	5x motor shield plate 5x fixing clip 5x wire clamp (cable diameter 0.157 ... 0.591 in ( 4 ... 15 mm))	EZAMBHXM018/S	1x motor shield plate 1x fixing clip 1x wire clamp (cable diameter 0.157 ... 0.591 in ( 4 ... 15 mm))
i510-C0.25/230-2				
i510-C0.37/230-1				
i510-C0.37/230-2				
i510-C0.55/230-1				
i510-C0.55/230-2				
i510-C0.75/230-1				
i510-C0.75/230-2				
i510-C1.1/230-1				
i510-C1.1/230-2				
i510-C1.5/230-1				
i510-C1.5/230-2				
i510-C2.2/230-1				
i510-C2.2/230-2				
i510-C4.0/230-3	EZAMBHXM015/M	5x motor shield plate 5x fixing clip 5x wire clamp (cable diameter 0.157 ... 0.591 in ( 4 ... 15 mm)) 5x M4x12 screw	EZAMBHXM015/S	1x motor shield plate 1x fixing clip 1x wire clamp (cable diameter 0.157 ... 0.591 in ( 4 ... 15 mm)) 1x M4x12 screw
i510-C5.5/230-3				
i510-C0.37/400-3	EZAMBHXM018/M	5x motor shield plate 5x fixing clip 5x wire clamp (cable diameter 0.157 ... 0.591 in ( 4 ... 15 mm))	EZAMBHXM018/S	1x motor shield plate 1x fixing clip 1x wire clamp (cable diameter 0.157 ... 0.591 in ( 4 ... 15 mm))
i510-C0.55/400-3				
i510-C0.75/400-3				
i510-C1.1/400-3				
i510-C1.5/400-3				
i510-C2.2/400-3				
i510-C3.0/400-3				
i510-C4.0/400-3				
i510-C5.5/400-3	EZAMBHXM015/M	5x motor shield plate 5x fixing clip 5x wire clamp (cable diameter 0.157 ... 0.591 in ( 4 ... 15 mm)) 5x M4x12 screw	EZAMBHXM015/S	1x motor shield plate 1x fixing clip 1x wire clamp (cable diameter 0.157 ... 0.591 in ( 4 ... 15 mm)) 1x M4x12 screw
i510-C7.5/400-3	EZAMBHXM016/M	5x motor shield plate 5x fixing clip 5x wire clamp (cable diameter 0.394 ... 0.787 in ( 10 ... 20 mm)) 5x M4x12 screw	EZAMBHXM016/S	1x motor shield plate 1x fixing clip 1x wire clamp (cable diameter 0.394 ... 0.787 in ( 10 ... 20 mm)) 1x M4x12 screw
i510-C11/400-3				



## Terminal strips

For connecting the inverter, the connections are equipped with pluggable terminal strips. Pluggable terminal strips are available separately for service purposes or if cable harnesses need to be physically separated.

Inverter	Terminal strips Mains connection X100		Terminal strips Motor connection X105	
	Order code	VPE	Order code	VPE
		Piece		Piece
i510-C0.25/230-1	EZA EVE032/M	10	EZA EVE038/M	10
i510-C0.37/230-1				
i510-C0.55/230-1				
i510-C0.75/230-1				
i510-C1.1/230-1	EZA EVE033/M			
i510-C1.5/230-1				
i510-C2.2/230-1				
i510-C0.25/230-2	EZA EVE034/M	10		
i510-C0.37/230-2				
i510-C0.55/230-2				
i510-C0.75/230-2				
i510-C1.1/230-2	EZA EVE035/M			
i510-C1.5/230-2				
i510-C2.2/230-2				
i510-C0.37/400-3	EZA EVE036/M	10		
i510-C0.55/400-3				
i510-C0.75/400-3				
i510-C1.1/400-3				
i510-C1.5/400-3				
i510-C2.2/400-3	EZA EVE037/M	5	EZA EVE039/M	
i510-C3.0/400-3				
i510-C4.0/400-3				

Terminal strips	Order code	VPE	Terminal strips	Order code	VPE
		Piece			Piece
Relay X9	EZA EVE030/M	10	CANopen / Modbus X216	EZA EVE042/M	10

# Accessories

Mounting  
DIN rail



## DIN rail

In accordance with EN 60175, the inverter can be mounted onto a DIN rail 35 mm x 7.5 mm.  
For this purpose, a mounting set is available.

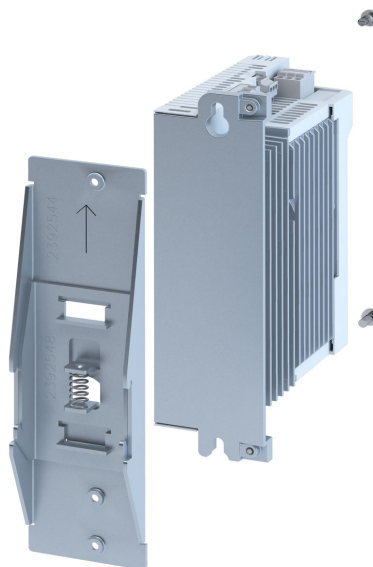

Mounting set	Can be used for inverters
Order code	Order code
I5ZAB0DR1S	I5xAE125x, I5xAE137x, I5xAE155x, I5xAE175x
I5ZAB0DR2S	I55AE175Ax, I5xAE211x, I5xAE215x, I5xAE222x, I5xxE230x, I5xxE240x, I5xxE255x



## Purchase order

### Notes on ordering

The inverters are supplied as complete devices. A control unit with basic I/O is integrated.

As the control unit cannot be extended, the i510 inverter is available in two versions:

- With CANopen/Modbus, switchable.
- Without network.

#### »EASY Product Finder«

The »EASY Product Finder« helps you to configure your required product in next to no time. In addition, you can retrieve all important technical details such as data sheets, CAD data, and EPLAN data.

The link and the QR code lead directly to the "EASY Product Finder": [EASY Product Finder](#)



# Purchase order

Order code



## Order code

### Delivery as complete inverter

Order data: Order code of the complete device.

### Order example

Description of the component	Order code
Complete inverter	I51AE175F10010001S
3-phase mains connection 400 V	
Power 0.75 kW (i510-C0.75/400-3)	
Without safety engineering (not available for i510)	
Default setting of parameters: EU region (50-Hz systems)	
Basic I/O with CANopen/Modbus	

### i510 inverter

Power		Inverter	Order code	
kW	hp			
1-phase mains connection 230/240 V, EMC filter integrated				
0.25	0.33	i510-C0.25/230-1	I51AE125B1	OV1
0.37	0.5	i510-C0.37/230-1	I51AE137B1	
0.55	0.75	i510-C0.55/230-1	I51AE155B1	
0.75	1	i510-C0.75/230-1	I51AE175B1	
1.1	1.5	i510-C1.1/230-1	I51AE211B1	
1.5	2	i510-C1.5/230-1	I51AE215B1	
2.2	3	i510-C2.2/230-1	I51AE222B1	
1/3-phase mains connection 230/240 V, EMC filter not integrated				
0.25	0.33	i510-C0.25/230-2	I51AE125D1	OVO
0.37	0.5	i510-C0.37/230-2	I51AE137D1	
0.55	0.75	i510-C0.55/230-2	I51AE155D1	
0.75	1	i510-C0.75/230-2	I51AE175D1	
1.1	1.5	i510-C1.1/230-2	I51AE211D1	
1.5	2	i510-C1.5/230-2	I51AE215D1	
2.2	3	i510-C2.2/230-2	I51AE222D1	
4	5.5	i510-C4.0/230-3	I51AE240C1	
5.5	7.5	i510-C5.5//230-3	I51AE255C1	
3-phase mains connection 400/480 V, EMC filter integrated				
0.37	0.5	i510-C0.37/400-3	I51AE137F1	OV1
0.55	0.75	i510-C0.55/400-3	I51AE155F1	
0.75	1	i510-C0.75/400-3	I51AE175F1	
1.1	1.5	i510-C1.1/400-3	I51AE211F1	
1.5	2	i510-C1.5/400-3	I51AE215F1	
2.2	3	i510-C2.2/400-3	I51AE222F1	
3	4	i510-C3.0/400-3	I51BE230F1	
4	5.5	i510-C4.0/400-3	I51BE240F1	
5.5	7.5	i510-C5.5/400-3	I51AE255F1	
7.5	10	i510-C7.5/400-3	I51BE275F1	
11	15	i510-C11/400-3	I51BE311F1	
Application				
Default parameter setting: Region EU (50-Hz networks)				0
Default parameter setting: Region US (60-Hz networks)				1
Design types				
Basic I/O without network				000S
Basic I/O with CANopen/Modbus				001S





## Environmental notes and recycling

Lenze has been certified to the worldwide environmental management standard for many years (DIN EN ISO 14001). As part of our environmental policy and the associated climate responsibility, please note the following information on hazardous ingredients and the recycling of Lenze products and their packaging:



Lenze products are partly subject to the EU Directive on the restriction of certain hazardous substances in electrical and electronic equipment 2011/65/EU: RoHS Directive [UKCA: S.I. 2012/3032 - The Restriction of the Use of Certain Hazardous Substances in Electrical and Electronic Equipment Regulations 2012] . This is documented accordingly in the EU declaration of conformity and with the CE mark.



Lenze products are not subject to EU Directive 2012/19/EU: Directive on waste electrical and electronic equipment (WEEE) [UKCA: S.I. 2013/3113 - The Waste Electrical and Electronic Equipment Regulations 2013] , but some contain batteries/rechargeable batteries in accordance with EU Directive 2006/66/EC: Battery Directive [UKCA: S.I. 2009/890 - The Waste Batteries and Accumulators Regulations 2009] . The disposal route, which is separate from household waste, is indicated by corresponding labels with the "crossed-out trash can". Any batteries/rechargeable batteries included are designed to last the life of the product and do not need to be replaced or otherwise removed by the end user.



Lenze products are usually sold with cardboard or plastic packaging. This packaging complies with EU Directive 94/62/EC: Directive on packaging and packaging waste [UKCA: S.I. 1997/648 - The Producer Responsibility Obligations (Packaging Waste) Regulations 1997] . The required disposal route is indicated by material-specific labels with the "recycling triangle". Example: "21 - other cardboard"

REACH

Lenze products are subject to REGULATION (EC) No 1907/2006: REACH Regulation [UKCA: S.I. 2008/2852 - The REACH Enforcement Regulations 2008] . When used as intended, exposure of substances to humans, animals and the environment is excluded.

Lenze products are industrial electrical and electronic products and are disposed of professionally. Both the mechanical and electrical components such as electric motors, gearboxes or inverters contain valuable raw materials that can be recycled and reused. Proper recycling and thus maintaining the highest possible level of recyclability is therefore important and sensible from an economic and ecological point of view.

- Coordinate professional disposal with your waste disposal company.
- Separate mechanical and electrical components, packaging, hazardous waste (e.g. gear oils) and batteries/rechargeable batteries wherever possible.
- Dispose of the separated waste in an environmentally sound and proper manner (no household waste or municipal bulky waste).

What?	Material	Disposal instructions
Pallets	Wood	Return to manufacturers, freight forwarders or reusable materials collection system
Packaging material	Paper, cardboard, pasteboard, plastics	Collect and dispose of separately
Products		
Electronic devices	Metal, plastics, circuit boards, heatsinks	As electronic waste give to professional disposer for recycling
Gearbox	Oil	Drain oil and dispose of separately
	Casting, steel, aluminium	Dispose as metal scrap
Motors	Casting, copper, rotors, magnets, potting compound	As engine scrap give to professional disposer for recycling
Dry-cell batteries/rechargeable batteries		As used batteries give to professional disposer for recycling



Further information on Lenze's environmental and climate responsibility and on the topic of energy efficiency can be found on the Internet:

[www.Lenze.com](http://www.Lenze.com) → search word: "Sustainability"



## Appendix

### Good to know

#### Operating modes of the motor

Operating modes S1 ... S10 as specified by EN 60034-1 describe the basic stress of an electrical machine.

In continuous operation a motor reaches its permissible temperature limit if it outputs the rated power dimensioned for continuous operation. However, if the motor is only subjected to load for a short time, the power output by the motor may be greater without the motor reaching its permissible temperature limit. This behaviour is referred to as overload capacity.

Depending on the duration of the load and the resulting temperature rise, the required motor can be selected reduced by the overload capacity.

#### The most important operating modes

Continuous operation S1	Short-time operation S2
<p>Operation with a constant load until the motor reaches the thermal steady state. The motor may be actuated continuously with its rated power.</p>	<p>Operation with constant load; however, the motor does not reach the thermal steady state. During the following standstill, the motor winding cools down to the ambient temperature again. The increase in power depends on the load duration.</p>



Intermittent operation S3	Non-intermittent periodic operation S6
<p>Sequence of identical duty cycles comprising operation with a constant load and subsequent standstill. Start-up and braking processes do not have an impact on the winding temperature. The steady-state is not reached. The guide values apply to a cycle duration of 10 minutes. The power increase depends on the cycle duration and on the load period/downtime ratio.</p>	<p>Sequence of identical duty cycles comprising operation with a constant load and subsequent no-load operation. The motor cools down during the no-load phase. Start-up and braking processes do not have an impact on the winding temperature. The steady-state is not reached. The guide values apply to a cycle duration of 10 minutes. The power increase depends on the cycle duration and on the load period/idle time ratio.</p>

**P** Power  
**t** Time  
 $t_L$  Idle time  
 $\vartheta$  Temperature

**$P_v$**  Power loss  
 $t_B$  Load period  
 $t_S$  Cycle duration



**Motor control types**

The inverter provides various motor control types.

**Linear V/f characteristic control**

The output voltage is increased proportionately to the output frequency.

In case of low output frequencies, the motor voltage can be increased to ensure a minimum current for the breakaway torque. In the field weakening range, the output voltage of the inverter is constant (mains voltage) and the frequency can be further increased depending on the load. The maximum torque of the motor is reduced proportionately to the square of the frequency increase, the maximum output power of the motor being constant.

Application areas are for instance: Single drives with constant load.

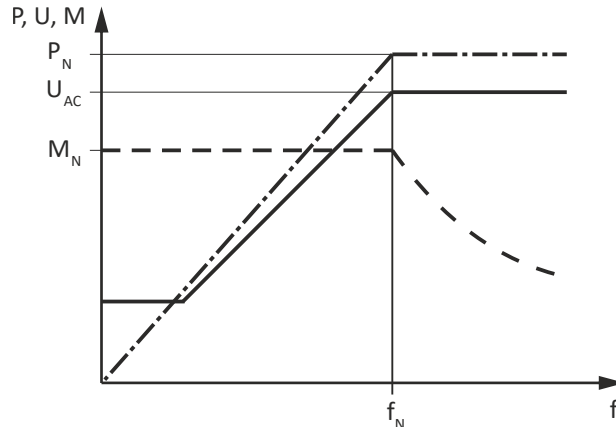

P Power  
 V Voltage  
 M Torque  
 f Frequency

$P_N$  Rated power  
 $U_{AC}$  Mains voltage  
 $M_N$  Rated torque  
 $f_N$  Rated frequency



### Square-law V/f characteristic control

The output voltage is increased squaredly to the output frequency.

In case of low output frequencies, the motor voltage can be increased to ensure a minimum current for the breakaway torque. In the field weakening range, the output voltage of the inverter is constant (mains voltage) and the frequency can be further increased depending on the load. The maximum torque of the motor is reduced squaredly to the frequency increase, the maximum output power of the motor being constant.

Application areas are for instance:

- Pumps
- Fans
- Ventilators

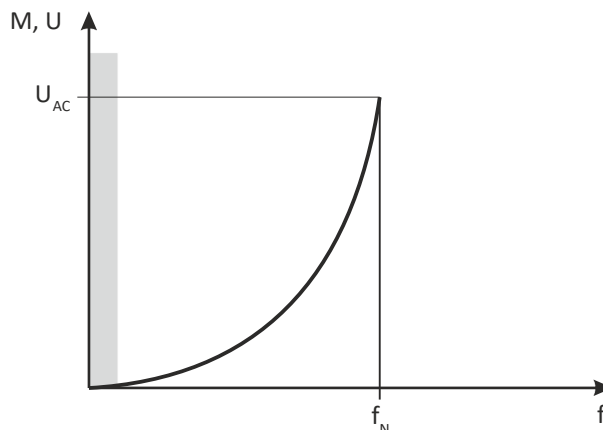

V	Voltage	$U_{AC}$	Mains voltage
f	Frequency	$f_N$	Rated frequency
M	Torque		

### VFCeco

The VFCeco mode has a special effect in the partial load operational range. Usually, three-phase AC motors are supplied there with a higher magnetising current than required by the operating conditions. The VFCeco mode reduces the losses in the partial load operational range so that savings up to 30 % are possible.

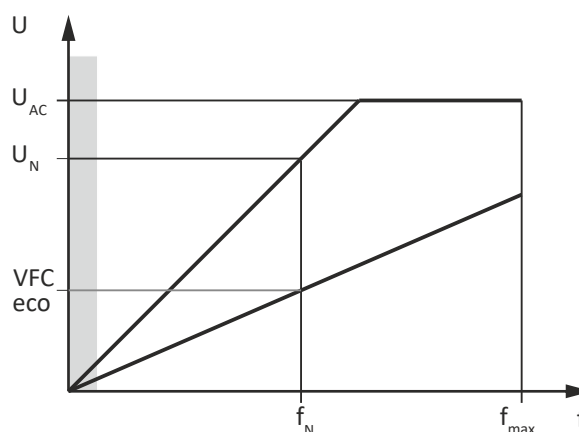

V	Voltage	f	Frequency
$U_{AC}$	Mains voltage	$f_N$	Rated frequency
$U_N$	Rated voltage	$f_{max}$	Max. frequency

# Appendix

Good to know  
Switching frequencies



## Sensorless vector control (SLVC)

In vector control, an inverted voltage model is used for calculation. The parameters are detected via a parameter identification. The inverter determines the angle between current and voltage. This imposes a current on the motor”.

Compared to the V/f characteristic control, the vector control serves to achieve improved drive characteristics thanks to:

- higher torque throughout the entire speed range
- higher speed accuracy and higher concentricity factor
- higher efficiency

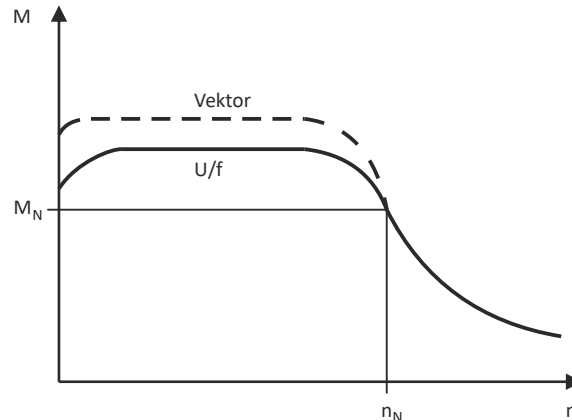

M Torque  
n Speed

$M_N$  Rated torque  
 $n_N$  Rated speed

Application areas are for instance:

- Single drives with changing loads
- Single drives with high starting duty
- Sensorless speed control of three-phase AC motors

## Switching frequencies

On an inverter, the term "switching frequency" is understood to mean the frequency with which the input and outputs of the output module (inverter) are switched. On an inverter, the switching frequency can generally be set to values between 2 and 16 kHz, whereby the selection is based on the respective power output.

As switching the modules cause heat losses, the inverter can provide higher output currents at low switching frequencies than at high frequencies. Additionally, it is distinguished between the operation at a permanently set switching frequency and a variably set switching frequency. Here, the switching frequency is automatically reduced as a function of the device utilization.

At a higher switching frequency, the noise generation is less.

Options for the switching frequency:

- 2 kHz
- 4 kHz
- 8 kHz
- 12 kHz
- 16 kHz
- variable (automatic adaptation)



## Enclosures

The protection class indicates the suitability of a product for specific ambient conditions with regard to humidity as well as the protection against contact and the ingress of foreign particles. The protection classes are classified in the EN 60034-5/ EN IEC 60529.

The first code number after the code letters IP indicates the protection against the ingress of foreign particles and dust. The second code number refers to the protection against the ingress of humidity.

Code number 1	Degree of protection	Code number 2	Degree of protection
0	No protection	0	No protection
1	Protection against the ingress of foreign particles $d > 50$ mm. No protection in case of deliberate access.	1	Protection against vertically dripping water (dripping water).
2	Protection against medium-sized foreign particles, $d > 12$ mm, keeping away fingers or the like.	2	Protection against diagonally falling water (dripping water), $15^\circ$ compared to normal service position.
3	Protection against small foreign particles $d > 2.5$ mm. Keeping away tools, wires or the like.	3	Protection against spraying water, up to $60^\circ$ from vertical.
4	Protection against granular foreign particles, $d > 1$ mm, keeping away tools, wire or the like.	4	Protection against spraying water from all directions.
5	Protection against dust deposits (dust-protected), complete protection against contact.	5	Protection against water jets from all directions.
6	Protection against the ingress of dust (dust-proof), complete protection against contact.	6	Protection against choppy seas or heavy water jets (flood protection).



## Glossary

### Definitions in functional safety

Abbreviation	Meaning
AIE	Acknowledge In Error, error acknowledgement
AIS	Acknowledge In Stop, restart acknowledgement
OFF state	Triggered signal status of the safety sensors
CCF	Common Cause Error (also $\beta$ -value)
EC_FS	Error Class Fail Safe
EC_SS1	Error Class Safe Stop 1
EC_SS2	Error Class Safe Stop 2
EC_STO	Error Class Safe Torque Off Stop 0
ON state	Signal status of the safety sensors in normal operation
FIT	Failure In Time, 1 FIT = $10^{-9}$ Error/h
FMEA	Failure Mode and Effect Analysis
FSoE	FailSafe over EtherCAT
GSDML	Device description file with PROFINET-specific data to integrate the configuring software of a PROFINET controller.
HFT	Hardware Failure Tolerance
Cat.	Category according to EN ISO 13849-1
nBD	Speed value Base-Drive, internally determined actual speed from standard application
nSD	Safe-Drive speed value, internally determined actual speed from the safety application
n_safe	Actual speed determined from validation of nBD and nSD. Enters the further processing of the speed-dependent safety functions.
OSSD	Output Signal Switching Device, tested signal output
pBD	Base-Drive position value, internally determined actual position from standard application
pSD	Safe-Drive position value, internally determined actual position from the safety application
p_safe	Actual position determined from validation of pBD and pSD. Enters the further processing of the position-dependent safety functions.
PELV	Protective Extra Low Voltage
PL	Performance Level according to EN ISO 13849-1
PM	Plus-Minus – switched signal paths
PP	Plus-Plus – switched signal paths
PS	PROFIsafe
PWM	Pulse Width Modulation
SCS	Safe Creeping Speed
SD-In	Safe Digital Input
SD-Out	Safe Digital Output
SELV	Safety Extra Low Voltage
SFF	Safe Failure Fraction
SIL	Safety Integrity Level according to EN IEC 61508



Lenze SE  
Postfach 101352 · 31763 Hameln  
Hans-Lenze-Straße 1 · 31855 Aerzen  
GERMANY  
Hannover HRB 204803  
Phone +49 5154 82-0  
Fax +49 5154 82-2800  
sales.de@lenze.com  
www.Lenze.com